

st[®]

STARKE

LÖSUNGEN



STARKE

Der Partner für das komplette Sortiment an Konfektionsmaterial für die Planenverarbeitung, von hochwertigen Textilien bis hin zu innovativen Befestigungslösungen, die Benedikt Starke GmbH & Co. KG steht für Qualität und Vielfalt in jedem Detail. Unser umfangreiches Angebot deckt alle Bedürfnisse der Planenfertigung ab – egal, ob für Industrie, Handwerk oder Design. Mit unserer Expertise und einem starken Fokus auf Kundenservice sind wir Ihr zuverlässiger Lieferant und Berater für alle Projekte rund um die Planenverarbeitung.



Your partner for the complete range of tailoring materials for tarpaulin processing, from high-quality textiles to innovative fastening solutions, Benedikt Starke GmbH & Co. KG stands for quality and variety in every detail. Our extensive offering covers all the needs of tarpaulin manufacturing – whether for industry, craft, or design. With our expertise and a strong focus on customer service, we are your reliable supplier and advisor for all projects around tarpaulin processing.

tecosign

Ein Muss, wenn es um Präsentationssysteme für den Messe- und Ausstellungsbau geht. tecosign steht für Innovation, Design und Qualität. Unsere maßgeschneiderten Lösungen bringen Ihre Botschaften effektiv zum Ausdruck und sorgen für einen unvergesslichen Eindruck bei Ihrem Publikum. Egal, ob Sie auf der Suche nach mobilen Standsystemen oder kreativen Beleuchtungskonzepten sind – tecosign bietet eine breite Palette an Produkten, die sich durch einfache Handhabung, Langlebigkeit und einzigartiges Design auszeichnen. Verlassen Sie sich auf tecosign, um Ihre Marke ins rechte Licht zu rücken und Ihre Präsenz auf jeder Messe und Ausstellung zu maximieren.



A must-have when it comes to presentation systems for trade fairs and exhibitions. tecosign stands for innovation, design, and quality. Our customized solutions effectively convey your messages and ensure a memorable impression on your audience. Whether you're looking for mobile stand systems or creative lighting concepts, tecosign offers a wide range of products characterized by ease of use, durability, and unique design. Rely on tecosign to highlight your brand and maximize your presence at every trade fair and exhibition.

Das Starke-Team berät kompetent in allen Fragen rund um das große Angebot der Konfektionsmaterialien und Präsentationssysteme. Mehr als 3.000 Artikel lösen nahezu jede Aufgabenstellung – auch Ihre!

The Starke team provides expert advice on all questions relating to the wide range of ready-made materials and presentation systems. More than 3,000 articles solve almost every task – including yours!

ZEICHENERKLÄRUNG · LEGEND

unit/ pcs	Stückzahl pro Einheit pieces per unit	↔	Lochabstand hole spacing
unit/ m	Meter pro Einheit meters per unit	kg	Gewicht weight
∅	Durchmesser diameter	□	Außenmaß external dimensions
↔	Breite width	∅ I	Innendurchmesser intern dimensions
↕	Höhe height	W	Watt watt
→	Länge length	∅ O	Lochdurchmesser hole diameter
*	Dicke thickness	→	Spannweg way of stretch
↔	Reissfestigkeit tear resistance		



Alukederschienen
Aluminium keder rails



Bilderrahmenspannprofile
Tension frame systems for pictures



Wandabspannsysteme
Wall suspension system



Seilsysteme
Cable systems



Zubehör
Accessories



Seile
Cables



Keder & Zubehör
Keders & Accessories



Bänder
Belts



Verschlüsse
Fasteners



Ösen
Eyelets



Planenbeschläge
Tarpaulin fittings



Nieten
Rivets



Schiebeplanensysteme
Side curtain systems



Planenaufrollsysteme
Roll-Up systems for tarpaulins



Beriemung
Strapping



Werkzeuge & Maschinen
Tools & machinery



Zubehör
Accessories



STARKE AUSWAHL AUCH ONLINE

Besuchen Sie uns jederzeit online unter www.bstarke.de

Hier bieten wir Ihnen eine benutzerfreundliche Oberfläche mit einer breiten Produktpalette.

Unter dem Menüpunkt „Registrieren“ (www.bstarke.de/User/Register) können Sie sich ein individuelles Kunden-Konto anlegen und 24/7 zu Ihren Konditionen und Preisen einkaufen, Bestellungen aus der Vergangenheit einsehen, sowie Artikel-Favoriten auf Ihre persönliche Merkliste setzen um häufig verwendete Produkte jederzeit schnell nachzubestellen.

Unter dem Menüpunkt Video-Anleitungen finden Sie Anwendungstipps und Anweisungen zu unseren Produkten.

Unsere Aluminium-Profile können Sie auf den betreffenden Artikel Detail-Seiten sogar in 3D erleben.

Ihre Zufriedenheit ist stets unser Anspruch. Bei Fragen oder Anregungen stehen wir gerne jederzeit zur Verfügung und freuen uns über Ihr Feedback.

You can also visit us online at any time at www.bstarke.de

Here we offer you a user-friendly interface with a wide range of products.

Under the menu item "Register" (www.bstarke.de/User/Register) you can create an individual customer account and shop 24/7 at your conditions and prices, view orders from the past and add items to your personal favorites list to quickly reorder frequently used products at any time.

Under the menu item Video instructions you will find application tips and instructions for our products.

You can even experience our aluminum profiles in 3D on the relevant article detail pages.

Your satisfaction is always our aim. If you have any questions or suggestions, please do not hesitate to contact us at any time and we look forward to your feedback.



Besuchen Sie uns jederzeit online!
You can also visit us online at any time!



ONLINESHOP



AKTIONSWARE

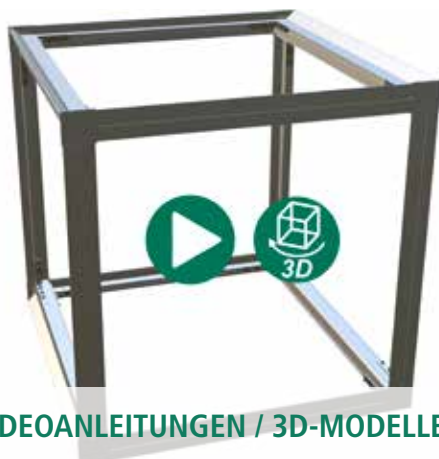

VIDEOANLEITUNGEN / 3D-MODELLE



NEUIGKEITEN



ALUKEDERSCHIENEN
ALUMINIUM
KEDER RAILS

ALUKEDERSCHIENEN · ALUMINIUM KEDER RAILS

Alukederschiene 17 x 44 mm Aluminium keder rail 17 x 44 mm

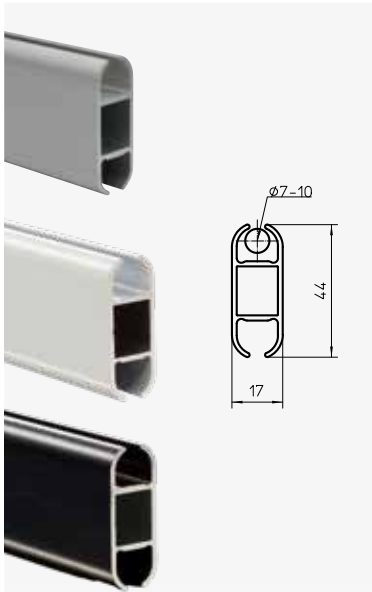

Nr. no.	VE PU	Breite width	Höhe height	Länge length	Farbe colour	Material · material
50064	1 / 12 St.	17 mm	44 mm	2.55 m		Alu blank · aluminium bare
50062	1 / 12 St.	17 mm	44 mm	6.05 m		Alu blank · aluminium bare
50065	1 / 12 St.	17 mm	44 mm	2.55 m		Alu eloxiert aluminium anodised
50008	1 / 12 St.	17 mm	44 mm	3.50 m		Alu eloxiert aluminium anodised
50015	1 / 12 St.	17 mm	44 mm	6.05 m		Alu eloxiert aluminium anodised
50259	1 / 12 St.	17 mm	44 mm	6.05 m	weiß white	Alu pulverbeschichtet aluminium powder-coated
50258	1 / 12 St.	17 mm	44 mm	6.05 m	schwarz black	Alu pulverbeschichtet aluminium powder-coated

Passender gerader Verbinder: Art. 50004 (Stahl verzinkt) + Art. 50742 (Kunststoff PA6).
Matching straight connector: no. 50004 (zinc plated) + no. 50742 (plastic PA6).

Alukederschiene 21 x 48 mm Aluminium keder rail 21 x 48 mm

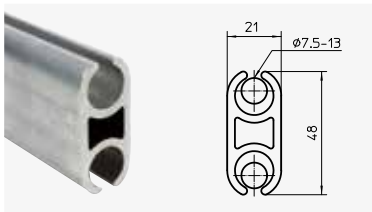

Nr. no.	VE PU	Breite width	Höhe height	Länge length	Material · material
50452	1 / 12 St.	21 mm	48 mm	6.05 m	Alu blank, starke Ausführung aluminium bare, heavy-duty design

Passender gerader Verbinder: Art. 50471.
Matching straight connector: no. 50471.

Alukederschiene 15 x 30 mm Aluminium keder rail 15 x 30 mm

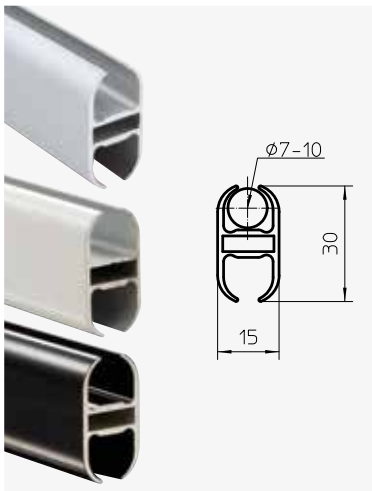

Nr. no.	VE PU	Breite width	Höhe height	Länge length	Farbe colour	Material · material
50126	1 / 12 St.	15 mm	30 mm	6.05 m		Alu eloxiert aluminium anodised
50114	1 / 12 St.	15 mm	30 mm	6.05 m	weiß white	Alu pulverbeschichtet aluminium powder-coated
50534	1 / 12 St.	15 mm	30 mm	6.05 m	schwarz black	Alu pulverbeschichtet aluminium powder-coated

Passender gerader Verbinder: Art. 50004 (Stahl verzinkt) + Art. 50742 (Kunststoff PA6).
Matching straight connector: no. 50004 (zinc plated) + no. 50742 (plastic PA6).



Alukederschiene Ø 30 mm Aluminium keder rail Ø 30 mm

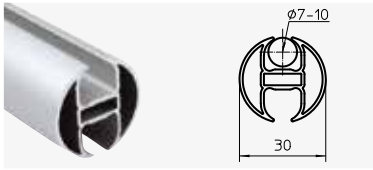

Nr. no.	VE PU	Ø	Länge length	Material · material
50017	1 / 12 St.	30 mm	6.05 m	Alu eloxiert · aluminium anodised

Passender gerader Verbinder: Art. 50004 (Stahl verzinkt) + Art. 50742 (Kunststoff PA6).
Matching straight connector: no. 50004 (zinc plated) + no. 50742 (plastic PA6).

4-Kanal Kederschiene 4-channel keder rail

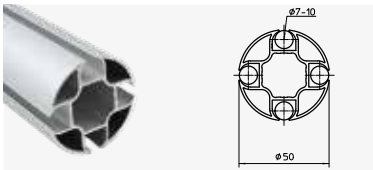

Nr. no.	VE PU	Ø	Länge length	Material · material
50202	1 / 6 St.	50 mm	6.05 m	Alu eloxiert · aluminium anodised

Passender gerader Verbinder: Art. 50004 (Stahl verzinkt) + Art. 50742 (Kunststoff PA6).
Matching straight connector: no. 50004 (zinc plated) + no. 50742 (plastic PA6).

Alukederschiene TS TS aluminium keder rail

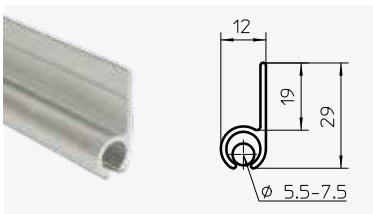

Nr. no.	VE PU	Breite width	Höhe height	Länge length	Material · material
50124	1 / 10 St.	12 mm	29 mm	6.05 m	Alu eloxiert · aluminium anodised
50127	1 / 10 St.	12 mm	29 mm	6.05 m	Alu blank · aluminium bare

Alukederschiene TS mit seitlicher Kederaufnahme TS aluminium keder rail with lateral keder attachment

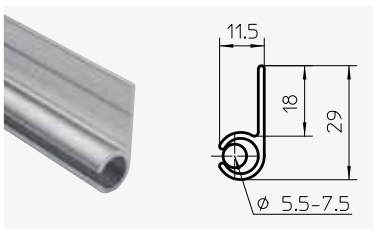

Nr. no.	VE PU	Breite width	Höhe height	Länge length	Ausführung, Material description, material
50701	1 / 20 St.	11,5 mm	29 mm	6.05 m	Mit seitlichem Kederausgang, für die Decken-Montage geeignet, Alu blank · with side keder outlet, suitable for ceiling mounting, aluminium bare

Alukederschiene Aluminium keder rail

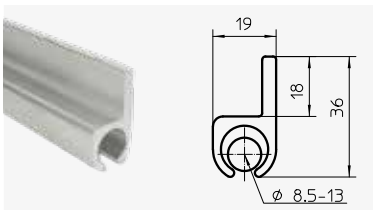

Nr. no.	VE PU	Breite width	Höhe height	Länge length	Material · material
50290	1 / 10 St.	19 mm	36 mm	6.05 m	Alu blank · aluminium bare

Zuschnitt für alle Alukederschiemen · cut-to-size sections for all aluminium keder rails

Art.-Nr. 50086 Sägezuschnitt · Art.-Nr. 50215 Zuschnitt auf Gehrung
Art.-No. 50086 Sawn section · Art.-No. 50215 Mitred sections

ALUKEDERSCHIENEN · ALUMINIUM KEDER RAILS

Doppelkederchiene

Double keder rail

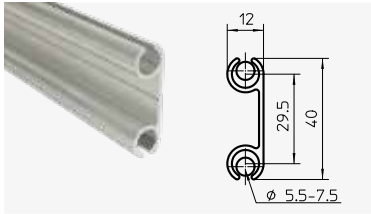

Nr. no.	VE PU	Breite width	Höhe height	Länge length	Material · material
50207	1 / 10 St.	12 mm	40 mm	6.05 m	Alu blank · aluminium bare

3-Kanal Kederchiene

3-channel keder rail

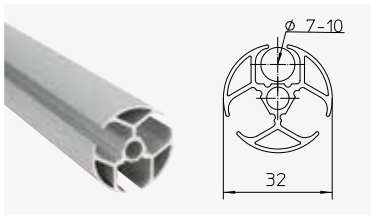

Nr. no.	VE PU	Ø	Länge length	Material · material
50348	1 / 12 St.	32 mm	6.05 m	Alu eloxiert · aluminium anodised

Kederchiene Hart-PVC

Rigid PVC keder rail



Nr. no.	VE PU	Breite width	Höhe height	Länge length	Farbe colour	Ausführung, Material description, material
50487	1 / 50 St.	15 mm	13 mm	5 m	weiß white	1-Kanal, passend für Ø 5.5 - 7.5 mm Keder, Hart-PVC · 1-channel model, suitable for 5.5 - 7.5 mm keder, hard-PVC
50696	1 / 50 St.	15 mm	13 mm	5 m	schwarz black	1-Kanal, passend für Ø 5.5 - 7.5 mm Keder, Hart-PVC · 1-channel model, suitable for 5.5 - 7.5 mm keder, hard-PVC
50488	1 / 50 St.	13 mm	21 mm	5 m	weiß white	2-Kanal, passend für Ø 5.5 - 7.5 mm Keder, Hart-PVC · 2-channel model, suitable for 5.5 - 7.5 mm, hard-PVC keder





Winkelprofil, Aluminium Angle profile, aluminium

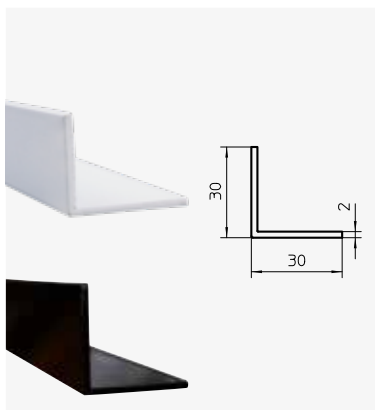

Nr. no.	VE PU	Breite width	Höhe height	Länge length	Farbe colour	Ausführung description
50546	1 / 10 St.	30 mm	30 mm	6.10 m	weiß RAL 9016 white RAL 9016	
50547	1 lfm.	30 mm	30 mm	lfm.	weiß RAL 9016 white RAL 9016	auf Ihr Bildmaß zugeschnitten tailored to your picture size
50548	1 / 10 St.	30 mm	30 mm	6.10 m	schwarz RAL 9005 black RAL 9005	
50549	1 lfm.	30 mm	30 mm	lfm.	schwarz RAL 9005 black RAL 9005	auf Ihr Bildmaß zugeschnitten tailored to your picture size

Klappschienset 12 x 30 mm, Alu eloxiert Clamp-rail set 12 x 30 mm, aluminium anodised



Nr. no.	VE PU	Breite width	Höhe height	Länge length	Material · material
50431	1 Set	12 mm	50 mm	500 mm	Alu eloxiert · aluminium anodised
50432	1 Set	12 mm	50 mm	594 mm	Alu eloxiert · aluminium anodised
50433	1 Set	12 mm	50 mm	841 mm	Alu eloxiert · aluminium anodised
50434	1 Set	12 mm	50 mm	1000 mm	Alu eloxiert · aluminium anodised
50435	1 Set	12 mm	50 mm	1200 mm	Alu eloxiert · aluminium anodised

Bestehend aus 2 Schienen, 2 Aufhängungen und 4 Endkappen.
Consisting of 2 rails, 2 hangers and 4 caps.

Klemmprofil zum Abhängen von leichten Stoffen, Kunststoff Clip profile suspending lightweight fabrics, plastic



Nr. no.	VE PU	Breite width	Höhe height	Länge length	Farbe colour	Ausführung · description
50189	1 St.	9 mm	18 mm	3.00 m	weiß white	inkl. 6 Abhänge-Ösen including 6 suspension eyelets
50190	1 St.	9 mm	18 mm	3.00 m	schwarz black	inkl. 6 Abhänge-Ösen including 6 suspension eyelets

Aluminiumwickelrohrprofil Aluminium winding tube profile

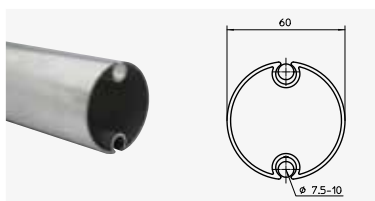

Nr. no.	VE PU	Ø	Länge length	Ausführung, Material description, material
11859	1 / 10 St.	60 mm	6.00 m	mit 2 Kedernuten, Alu blank with 2 keder grooves, aluminium bare

Gebogene Alukederschiene Aluminium keder rail, bent

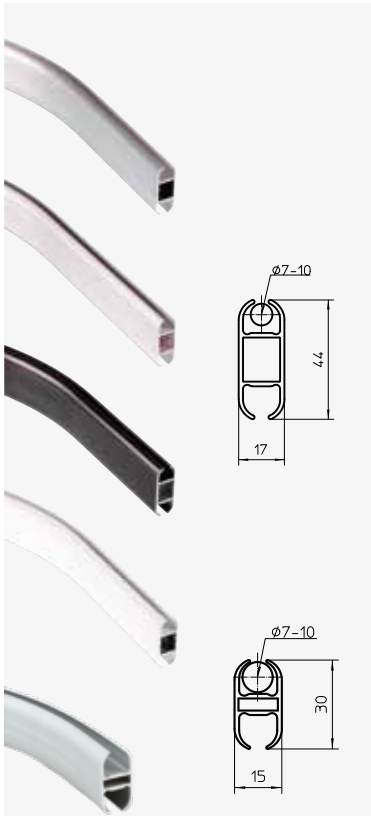

Nr. no.	VE PU	Breite width	Höhe height	Farbe Colour	Ausführung, Material description, material
50237	1 lfm	17 mm	44 mm		kleinster Biegeradius 250 mm, Alu blank · minimum bending radius 250 mm, aluminium bare
50192	1 lfm	17 mm	44 mm		kleinster Biegeradius 250 mm, Alu eloxiert · minimum bending radius 250 mm, aluminium anodised
50291	1 lfm	17 mm	44 mm	schwarz black	kleinster Biegeradius 250 mm, Alu pulverbeschichtet · minimum bending radius 250 mm, aluminium powder-coated
50292	1 lfm	17 mm	44 mm	weiß white	kleinster Biegeradius 250 mm, Alu pulverbeschichtet · minimum bending radius 250 mm, aluminium powder-coated
50206	1 lfm	15 mm	30 mm		kleinster Biegeradius 250 mm, Alu eloxiert · minimum bending radius 250 mm, aluminium anodised

Gebogene Alukederschiene Aluminium keder rail, bent

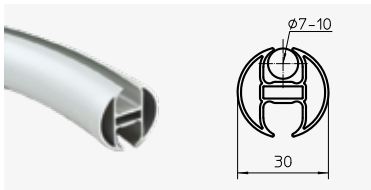

Nr. no.	VE PU	Ø	Ausführung, Material description, material
50205	1 lfm	30 mm	kleinster Biegeradius: 350 mm, Alu eloxiert minimum bending radius: 350 mm, aluminium anodised
50333	1 lfm	30 mm	mit horizontalen Kedernuten, kleinster Biegeradius: 350 mm, Alu eloxiert · with horizontal keder groove, minimum bending radius: 350 mm, aluminium anodised

Gebogenes Bilderrahmenprofil Picture frame profile, bent

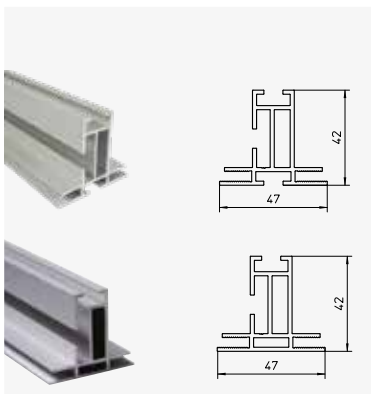

Nr. no.	VE PU	Breite width	Höhe height	Ausführung, Material description, material
50550	1 lfm	47 mm	42 mm	kleinster Biegeradius: 1500 mm, Alu eloxiert minimum bending radius: 1500 mm, aluminium anodised
50654	1 lfm	47 mm	42 mm	mit geschlossener Außenfläche, kleinster Biegeradius: 1500 mm, Alu eloxiert · with closed outer surface, minimum bending radius: 1500 mm, aluminium anodised

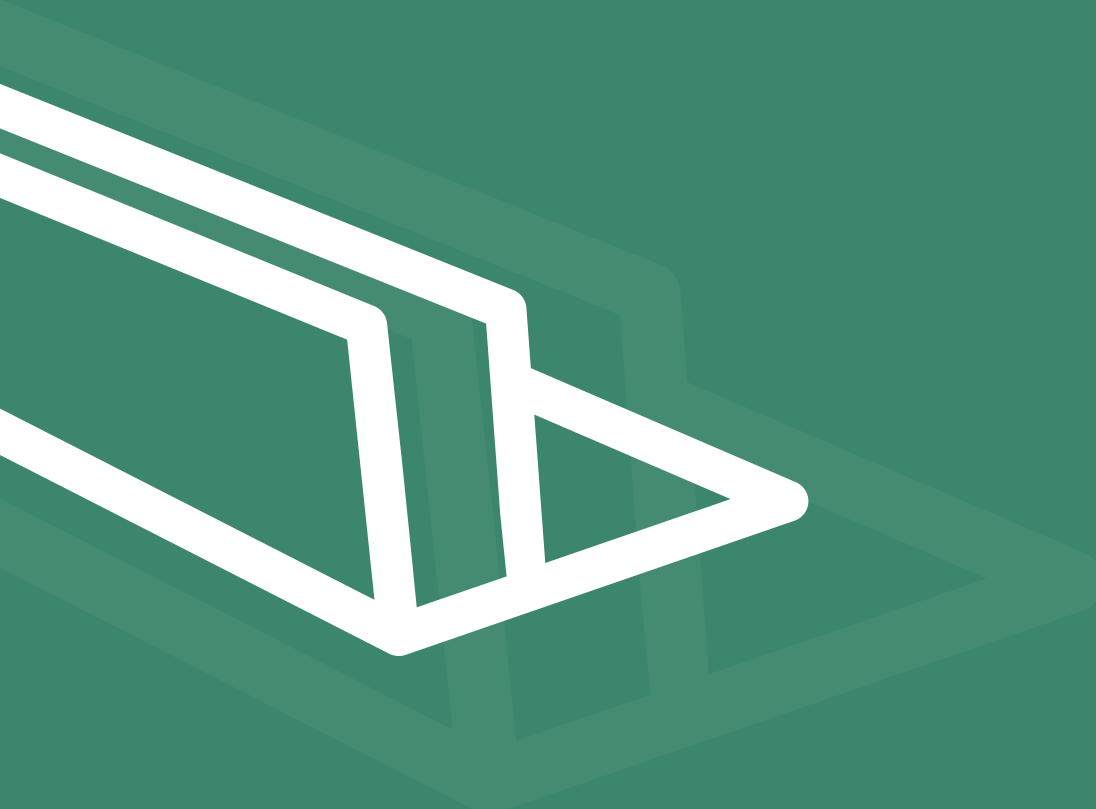

**BILDERRAHMEN-
SPANNSYSTEME
TENSION FRAME
SYSTEMS
FOR PICTURES**

Bilderrahmenprofil H-Profil Picture frame profile H-profile

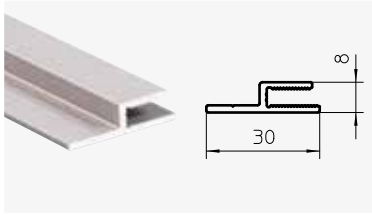

Nr. no.	VE PU	Breite width	Höhe height	Länge length	Ausführung, Material description, material
50413	1 / 30 St.	30 mm	8 mm	6.10 m	Alu eloxiert · aluminium anodised
50519	1 lfm	30 mm	8 mm		auf Ihr Bildmaß zugeschnitten, Alu eloxiert · tailored to your picture size, aluminium anodised

Bilderrahmenprofil F-Profil Picture frame profile F-profile

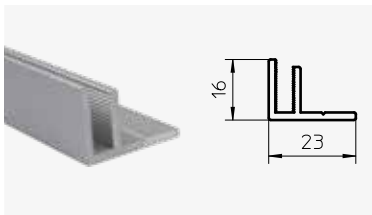

Nr. no.	VE PU	Breite width	Höhe height	Länge length	Ausführung, Material description, material
50516	1 / 30 St.	23 mm	16 mm	6.10 m	Alu eloxiert · aluminium anodised
50517	1 lfm	23 mm	16 mm		auf Ihr Bildmaß zugeschnitten, Alu eloxiert · tailored to your picture size, aluminium anodised

Bilderrahmenprofil tecosign „Mini“ Picture frame profile tecosign „mini“

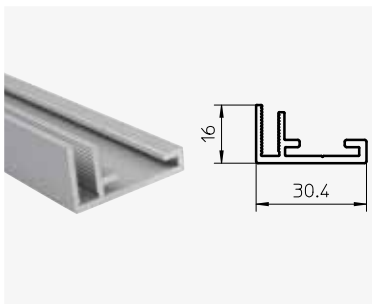

Nr. no.	VE PU	Breite width	Höhe height	Länge length	Ausführung, Material description, material
50537	1 / 10 St.	30.4 mm	16 mm	6.10 m	Alu eloxiert · aluminium anodised
50538	1 lfm	30.4 mm	16 mm		auf Ihr Bildmaß zugeschnitten, Alu eloxiert · tailored to your picture size, aluminium anodised

Passender Eckverbinder: Art. 50253 (Stahl verzinkt) + Art. 50743 (Kunststoff PA6).
Matching corner connector: no. 50253 (steel zinc plated) + no. 50743 (plastic PA6).

Passender gerader Verbinder: Art. 50303 (Stahl verzinkt) + Art. 50744 (Kunststoff PA6).
Matching straight connector: art. 50303 (steel zinc plated) + art. 50744 (plastic PA6).

Lochung der Bilderrahmenprofile (H-, F-, Mini- und Multi-Profil) mit Langloch 5.7 x 15 mm auf Kundenwunsch möglich (Artikel 50694).
Perforation of picture frame profiles (H-, F-, Mini- and Multi-Profile) with slotted hole 5.7 x 15 mm possible on customer request (article 50694).

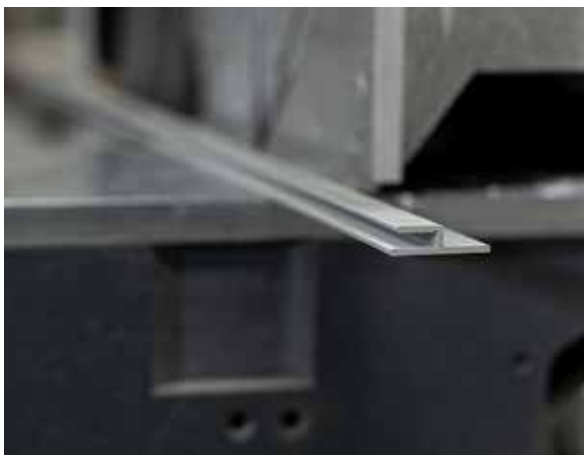

Bilderrahmenprofil tecosign „Multi“ Picture frame profile tecosign „multi“



2 Kедernuten ermöglichen
2 Rahmentiefen: 44 und 15 mm.
2 keder grooves provide 2 different
frame depths: 44 and 15 mm.

Nr. no.	VE PU	Breite width	Höhe height	Länge length	Farbe colour	Ausführung, Material description, material
50262	1 / 20 St.	44 mm	16 mm	6.10 m		Alu eloxiert · aluminium anodised
50295	1 lfm	44 mm	16 mm			auf Ihr Bildmaß zugeschnitten , Alu eloxiert tailored to your picture size , aluminium anodised
50263	1 / 12 St.	44 mm	16 mm	6.10 m	weiß white	Alu pulverbeschichtet aluminium powder-coated
50296	1 lfm	44 mm	16 mm		weiß white	auf Ihr Bildmaß zugeschnitten , Alu pulverbeschichtet · tailored to your picture size , aluminium powder-coated
50264	1 / 12 St.	44 mm	16 mm	6.10 m	schwarz black	Alu pulverbeschichtet aluminium powder-coated
50297	1 lfm	44 mm	16 mm		schwarz black	auf Ihr Bildmaß zugeschnitten , Alu pulverbeschichtet · tailored to your picture size , aluminium powder-coated

Passende Eckverbinder: Art. 50253/50743 (Rahmentiefe 15 mm) + Art. 50260 (Rahmentiefe 44 mm).
Matching corner connectors: no. 50253/50743 (frame depth 15 mm) + no. 50260 (frame depth 44 mm).

Passender gerader Verbinder: Art. 50303 (Stahl verzinkt) + Art. 50744 (Kunststoff PA6).
Matching straight connector: art. 50303 (steel zinc plated) + art. 50744 (plastic PA6).

Bilderrahmenprofil einfach, 30 x 42 mm Picture frame profile, single-sided, 30 x 42 mm

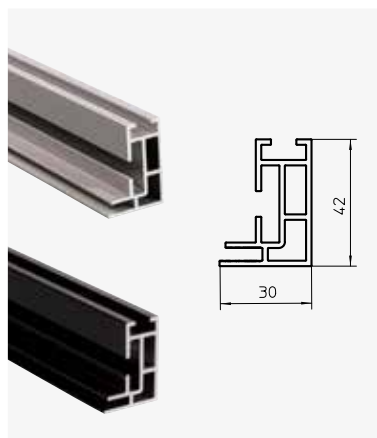

Nr. no.	VE PU	Breite width	Höhe height	Länge length	Farbe colour	Ausführung, Material description, material
50484	1 / 6 St.	30 mm	42 mm	6.10 m		Alu eloxiert · aluminium anodised
50505	1 lfm	30 mm	42 mm			auf Ihr Bildmaß zugeschnitten , Alu eloxiert tailored to your picture size , aluminium anodised
50724	1 / 6 St.	30 mm	42 mm	6.10 m	schwarz black	Alu pulverbeschichtet aluminium powder-coated
50725	1 lfm	30 mm	42 mm		schwarz black	auf Ihr Bildmaß zugeschnitten , Alu pulverbeschichtet · tailored to your picture size , aluminium powder-coated

Passender Eckverbinder: Art. 50463 (Stahl verzinkt) + Art. 50741 (Kunststoff PA6).
Matching corner connector: no. 50463 (steel zinc plated) + no. 50741 (plastic PA6).

Passender gerader Verbinder: Art. 50475 (Stahl verzinkt).
Matching straight connector: art. 50475 (steel zinc plated).

Bilderrahmenprofil einfach, 55 x 42 mm Picture frame profile, single-sided, 55 x 42 mm

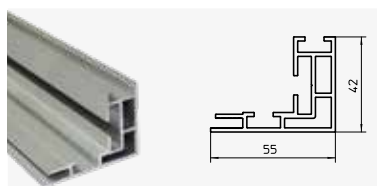

Nr. no.	VE PU	Breite width	Höhe height	Länge length	Ausführung, Material description, material
50570	1 / 6 St.	55 mm	42 mm	6.10 m	Alu eloxiert · aluminium anodised
50571	1 lfm	55 mm	42 mm		auf Ihr Bildmaß zugeschnitten , Alu eloxiert · tailored to your picture size , aluminium anodised

Passender Eckverbinder: Art. 50463 (Stahl verzinkt) + Art. 50741 (Kunststoff PA6).
Matching corner connector: no. 50463 (steel zinc plated) + no. 50741 (plastic PA6).

Passender gerader Verbinder: Art. 50475 (Stahl verzinkt).
Matching straight connector: art. 50475 (steel zinc plated).

Bilderrahmenprofil tecosign einfach, 85 x 42 mm

Picture frame profile tecosign single-sided, 85 x 42 mm

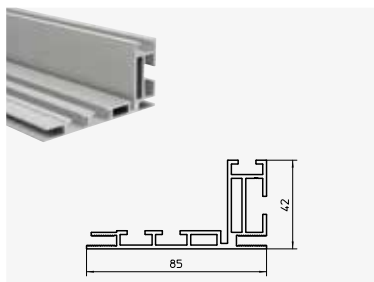

Nr. no.	VE PU	Breite width	Höhe height	Länge length	Ausführung, Material description, material
50524	1 / 6 St.	85 mm	42 mm	6.10 m	inkl. Einschub-Nut für Dibond-Platten (bis 4 mm Stärke), Alu eloxiert incl. slide-in groove for Dibond panels (up to 4 mm thickness), aluminium anodised
50529	1 lfm	85 mm	42 mm		auf Ihr Bildmaß zugeschnitten , Alu eloxiert · tailored to your picture size , aluminium anodised

Passender Eckverbinder: Art. 50463 (Stahl verzinkt) + Art. 50741 (Kunststoff PA6). Als zusätzliche Verstärkung in der vorderen Bilderrahmen-Nut: Art. 50685 L-Verbinder.

Matching corner connector: no. 50463 (steel zinc plated) + no. 50741 (plastic PA6). As additional reinforcement in the front picture frame groove: Art. 50685 L-connector.

Passender gerader Verbinder: Art. 50475 (Stahl verzinkt).

Matching straight connector: art. 50475 (steel zinc plated).

Bilderrahmenprofil doppelt, 47 x 42 mm, mit Außen-Nut

Picture frame profile double-sided, 47 x 42 mm, with external groove

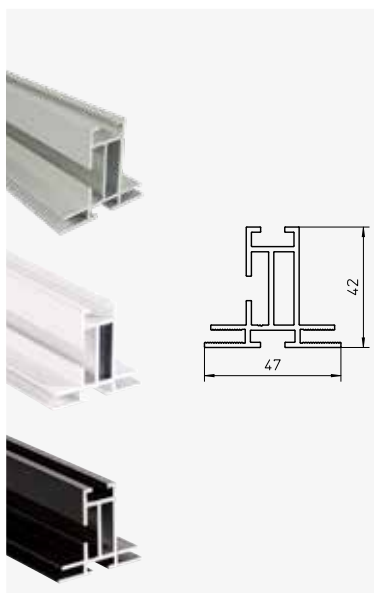

Nr. no.	VE PU	Breite width	Höhe height	Länge length	Farbe colour	Ausführung, Material description, material
50485	1 / 6 St.	47 mm	42 mm	6.10 m		Alu eloxiert · aluminium anodised
50506	1 lfm	47 mm	42 mm			auf Ihr Bildmaß zugeschnitten , Alu eloxiert tailored to your picture size , aluminium anodised
50625	1 / 6 St.	47 mm	42 mm	6.10 m	weiß white	Alu pulverbeschichtet aluminium powder-coated
50627	1 lfm	47 mm	42 mm		weiß white	auf Ihr Bildmaß zugeschnitten , Alu pulverbeschichtet · tailored to your picture size , aluminium powder-coated
50726	1 / 6 St.	47 mm	42 mm	6.10 m	schwarz black	Alu pulverbeschichtet aluminium powder-coated
50727	1 lfm	47 mm	42 mm		schwarz black	auf Ihr Bildmaß zugeschnitten , Alu pulverbeschichtet · tailored to your picture size , aluminium powder-coated

Passender Eckverbinder: Art. 50463 (Stahl verzinkt) + Art. 50741 (Kunststoff PA6).

Matching corner connector: no. 50463 (steel zinc plated) + no. 50741 (plastic PA6).

Passender gerader Verbinder: Art. 50475 (Stahl verzinkt).

Matching straight connector: art. 50475 (steel zinc plated).

Bilderrahmenprofil doppelt, 47 x 42 mm

Picture frame profile double-sided, 47 x 42 mm

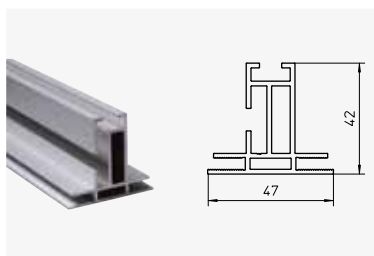

Nr. no.	VE PU	Breite width	Höhe height	Länge length	Ausführung, Material description, material
50540	1 / 6 St.	47 mm	42 mm	6.10 m	mit geschlossener Außenfläche, Alu eloxiert · with closed outer surface, aluminium anodised
50541	1 lfm	47 mm	42 mm		auf Ihr Bildmaß zugeschnitten , mit geschlossener Außenfläche, Alu eloxiert · tailored to your picture size , aluminium anodised

Passender Eckverbinder: Art. 50463 (Stahl verzinkt) + Art. 50741 (Kunststoff PA6).

Matching corner connector: no. 50463 (steel zinc plated) + no. 50741 (plastic PA6).

Passender gerader Verbinder: Art. 50475 (Stahl verzinkt).

Matching straight connector: art. 50475 (steel zinc plated).

Bilderrahmenprofil doppelt, 78 x 42 mm

Picture frame profile double-sided, 78 x 42 mm

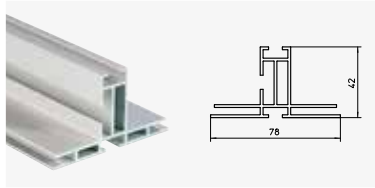

Nr. no.	VE PU	Breite width	Höhe height	Länge length	Ausführung, Material description, material
50715	1 / 6 St.	78 mm	42 mm	6.10 m	Alu eloxiert · aluminium anodised
50716	1 lfm	78 mm	42 mm		auf Ihr Bildmaß zugeschnitten, Alu eloxiert · tailored to your picture size, aluminium anodised

Passender Eckverbinder: Art. 50463 (Stahl verzinkt) + Art. 50741 (Kunststoff PA6).
Matching corner connector: no. 50463 (steel zinc plated) + no. 50741 (plastic PA6).

Passender gerader Verbinder: Art. 50475 (Stahl verzinkt).
Matching straight connector: art. 50475 (steel zinc plated).

Bilderrahmenprofil doppelt, 100 x 35 mm

Picture frame profile double-sided, 100 x 35 mm

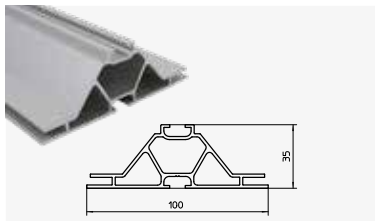

Nr. no.	VE PU	Breite width	Höhe height	Länge length	Ausführung, Material description, material
50331	1 / 6 St.	100 mm	35 mm	6.10 m	Alu eloxiert · aluminium anodised
50374	1 lfm	100 mm	35 mm		auf Ihr Bildmaß zugeschnitten, Alu eloxiert · tailored to your picture size, aluminium anodised

Passende Eckverbinder: no. 50344 + 50482. Bei großen Formaten empfehlen wir die zusätzliche Verwendung der Verstärkungsstrebe Art. 50731 für eine stabile Eckverbindung.
Matching corner connectors: no. 50344 + 50482. For large formats, we recommend the additional use of the reinforcing strut Art. 50731 for a stable corner connection.

Passender gerader Verbinder: Art. 50345 (Stahl verzinkt).
Matching straight connector: art. 50345 (steel zinc plated).

Bilderrahmenprofil doppelt, 100 x 35 mm

Picture frame profile double-sided, 100 x 35 mm

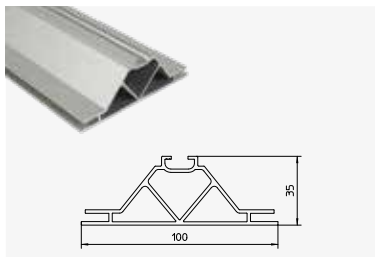

Nr. no.	VE PU	Breite width	Höhe height	Länge length	Ausführung, Material description, material
50414	1 / 6 St.	100 mm	35 mm	6.10 m	mit geschlossener Außenfläche, Alu eloxiert · with closed outer surface, aluminium anodised
50450	1 lfm	100 mm	35 mm		mit geschlossener Außenfläche, auf Ihr Bildmaß zugeschnitten, Alu eloxiert · with closed outer surface, tailored to your picture size, alu- minium anodised

Passender Eckverbinder: no. 50344. Bei großen Formaten empfehlen wir die zusätzliche Verwendung der Verstärkungsstrebe Art. 50731 für eine stabile Eckverbindung.
Matching corner connector: no. 50344. For large formats, we recommend the additional use of the reinforcing strut Art. 50731 for a stable corner connection.

Passender gerader Verbinder: Art. 50345 (Stahl verzinkt).
Matching straight connector: art. 50345 (steel zinc plated).

Bilderrahmenprofil doppelt, 100 x 25 mm

Picture frame profile double-sided, 100 x 25 mm

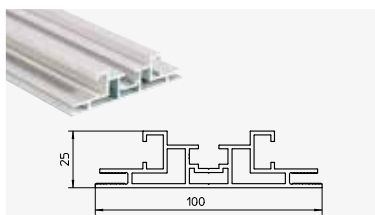

Nr. no.	VE PU	Breite width	Höhe height	Länge length	Ausführung, Material description, material
50622	1 / 6 St.	100 mm	25 mm	6.10 m	Alu eloxiert · aluminium anodised
50623	1 lfm	100 mm	25 mm		Auf Ihr Bildmaß zugeschnitten, Alu eloxiert · tailored to your picture size, aluminium anodised

Passender Eckverbinder: no. 50624 (2 Stück pro Eckverbindung).
Matching corner connector: no. 50624 (2 pieces per corner joint).

Passender gerader Verbinder: Art. 50345 (Stahl verzinkt) / 2 Stück pro Verbindung.
Matching straight connector: art. 50345 (steel zinc plated) / 2 pieces per connection.

Bilderrahmenprofil tecosign cube „65“ Picture frame profile tecosign cube “65”

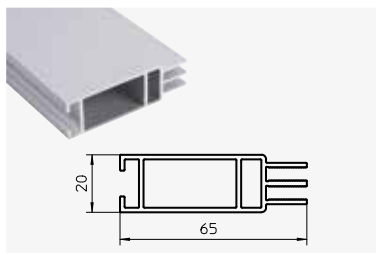

Nr. no.	VE PU	Breite width	Höhe height	Länge length	Ausführung, Material description, material
50580	1 / 4 St.	20 mm	65 mm	6.10 m	zum Erstellen von Kuben, Alu eloxiert for creating cubes, aluminium anodised
50581	1 lfm	20 mm	65 mm		zum Erstellen von Kuben, auf Ihr Bildmaß zugeschnitten , Alu eloxiert for creating cubes, tailored to your picture size , aluminium anodised

Passender Eckverbinder Art. 50582.
Matching corner connector: no. 50582.

Passender gerader Verbinder: Art. 50583.
Matching straight connector: art. 50583.

Bilderrahmenprofil OPTION 47 Picture Frame Profile OPTION 47

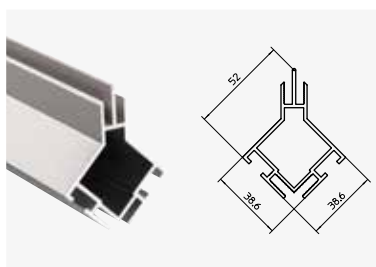

Nr. no.	VE PU	Breite width	Höhe height	Länge length	Ausführung, Material description, material
50720	1 / 6 St.	52 mm	52 mm	6.10 m	zur Herstellung von 90° Ecken in Kombination mit dem doppelten Bilderrahmenprofil 47 x 42 mm (Art. 50506/50541), Alu eloxiert for producing 90° corners in combination with the double, picture frame 47 x 42 mm (no. 50506/50541), aluminium anodised
50721	1 lfm	52 mm	52 mm		

Passender Eckverbinder Art. 50717 (eingesetzt in die Innen-Nut).
Passende Endkappen finden Sie auf Seite 44.
Matching corner connector Art. 50717 (inserted in the inner groove).
Matching end caps can be found on page 44.

Tutorial Option 47/78
Tutorial Option 47/78



Bilderrahmenprofil OPTION 78 Picture Frame Profile OPTION 78

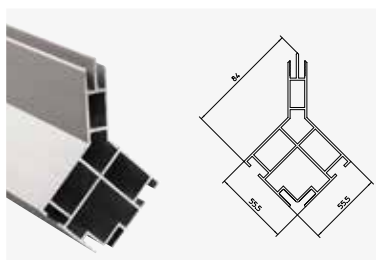

Nr. no.	VE PU	Breite width	Höhe height	Länge length	Ausführung, Material description, material
50722	1 St.	84 mm	84 mm	6.10 m	zur Herstellung von 90° Ecken in Kombination mit dem doppelten Bilderrahmenprofil 78 x 42 mm (Art. 50716), Alu eloxiert for producing 90° corners in combination with the double picture frame 78 x 42 mm (no. 50716), aluminium anodised
50723	1 lfm	84 mm	84 mm		

Passender Eckverbinder Art. 50759 (eingesetzt in die Innen-Nut). Passende Endkappen finden Sie auf Seite 44.
Matching corner connector Art. 50759 (inserted in the inner groove). Matching end caps can be found on page 44.

Verstärkungsprofil Reinforcement profile

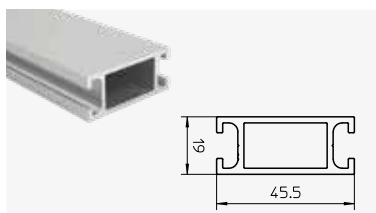

Nr. no.	VE PU	Breite width	Höhe height	Länge length	Ausführung, Material description, material
50332	1 / 6 St.	45.5 mm	19 mm	6.10 m	Alu eloxiert · aluminium anodised
50380	1 lfm	45.5 mm	19 mm		auf ihr Bildmaß zugeschnitten , Alu eloxiert · tailored to your picture size , aluminium anodised

Zur Stabilisierung von Bildern größerer Maße in Verbindung mit Zargenschloss 50672.
For stabilising images of larger dimensions in combination with frame lock 50672.

Passender gerader Verbinder: Art. 50345 (Stahl verzinkt).
Matching straight connector: art. 50345 (steel zinc plated).

Verstärkungsprofil „light“ Reinforcement profile „light“

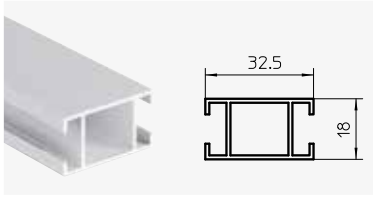

Nr. no.	VE PU	Breite width	Höhe height	Länge length	Ausführung, Material description, material
50651	1 / 5 St.	32.5 mm	18 mm	6.10 m	Alu eloxiert · aluminium anodised
50652	1 lfm	32.5 mm	18 mm		auf Ihr Bildmaß zugeschnitten, Alu eloxiert · tailored to your picture size, aluminium anodised

Zur Stabilisierung von Bildern größerer Maße in Verbindung mit Zargenschloss 50526.
For stabilising images of larger dimensions in combination with frame lock 50526.

Passender gerader Verbinder: Art. 50345 (Stahl verzinkt).
Matching straight connector: art. 50345 (steel zinc plated).

Einsteckprofil für Dibond-Platten Insertion profile for dibond plates

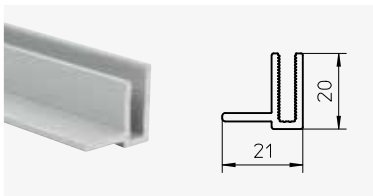

Nr. no.	VE PU	Breite width	Höhe height	Länge length	Ausführung, Material description, material
50629	1 St.	21 mm	20 mm	6.10 m	Alu eloxiert · aluminium anodised
50630	1 lfm	21 mm	20 mm		auf ihr Bildmaß zugeschnitten, Alu eloxiert · tailored to your picture size, aluminium anodised

Für Dibond Plattenstärken bis 4 mm. Das Einsteck-Profil wird in die vorhandene Flachkeder-Nut des Rahmens gesteckt.
For Dibond panel thicknesses up to 4 mm. The plug-in profile is inserted into the existing flat keder groove of the frame.

Verbinder für Profil „multi“ + „mini“ Connector for „multi“ + „mini“ profiles



Nr. no.	VE PU	Breite width	Höhe height	Länge length	Ausführung, Material description, material
50253	1 / 20 St.	20 mm	60 mm	60 mm	Eckverbinder, Stahl verzinkt corner connector, steel zinc plated
50303	1 / 20 St.	20 mm		120 mm	gerader Verbinder, Stahl verzinkt straight connector, steel zinc plated
50743	1 / 20 St.	20 mm	60 mm	60 mm	Eckverbinder, Kunststoff PA6 corner connector, plastic PA6
50744	1 / 20 St.	20 mm		120 mm	gerader Verbinder, Kunststoff PA6 straight connector, plastic PA6

Für 15 mm sichtbare Rahmentiefe.
For 15 mm visible frame depth.

L-Verbinder für Profil „multi“ L-Connector for profile „multi“



Nr. no.	VE PU	Breite width	Höhe height	Länge length	Material · material
50260	1 / 20 St.	20 mm	60 mm	60 mm	Aluminium · aluminium

Für 44 mm sichtbare Rahmentiefe.
For 44 mm visible frame depth.

Eckverbinder „perfect“ Corner connector “perfect”



Nr. no.	VE PU	Breite width	Höhe height	Länge length	Material material
50463	1 / 20 St.	25 mm	110 mm	110 mm	Stahl verzinkt · steel zinc plated
50741	1 / 20 St.	25 mm	104 mm	104 mm	Kunststoff PA6 · plastic PA6

Gerader Verbinder „perfect“ “perfect” connector, straight design



Nr. no.	VE PU	Breite width	Länge length	Ausführung, Material description, material
50475	1 / 20 St.	25 mm	120 mm	Stahl verzinkt · steel zinc plated

Eckverbinder für Bilderrahmen corner connector for picture frames



Nr. no.	VE PU	Breite width	Höhe height	Länge length	Ausführung, Material description, material
50344	1 / 20 St.	14 mm	50 mm	50 mm	passend für Profile 50331 + 50414, Stahl verzinkt fits for profiles 50331 + 50414, steel zinc plated

Eckverbinder Corner connector



Nr. no.	VE PU	Breite width	Höhe height	Länge length	Farbe colour	Ausführung, Material description, material
50482	1 / 20 St.	12 mm	43 mm	43 mm	grau grey	für zusätzliche Eckstabilisierung der Bilderrahmenprofile 50331, Kunststoff · additional corner stabilisation of picture frame profiles 50331, plastic

Verbinder „gerade“ Connector “straight”



Nr. no.	VE PU	Breite width	Länge length	Ausführung, Material description, material
50345	1 / 20 St.	14 mm	100 mm	passend für Profile 50331 + 50414, Stahl verzinkt fits for profiles 50331 + 50414, steel zinc plated

L-Verbinder für Bilderrahmenprofil tecosign 85 L-Connector for picture frame profile tecosign 85

Nr. no.	VE PU	Breite width	Länge length	Ausführung, Material description, material
50685	1 / 20 St.	50 mm	50 mm	als zusätzliche Verstärkung in der vorderen Bilderrahmen-Nut verwendbar, Stahl verzinkt can be used as additional reinforcement in the front picture frame groove, steel zinc plated

Eckverbinder OPTION Corner connector OPTION

Nr. no.	VE PU	Breite width	Länge length	Ausführung, Material description, material
50717	1 St.	100 mm	100 mm	Stahl verzinkt, passend für Tecosign „Option 47 + 78“ Eckprofile, wird in die Innen-Nut des Bilderrahmens eingesetzt, Stahl verzinkt fits for Tecosign „Option 47 + 78“ corner profiles, is inserted into the inner groove of the picture frame, steel zinc plated

Montagehilfen für OPTION Profile 47 + 78 Mounting aids for OPTION profiles 47 + 78

Nr. no.	VE PU	Farbe colour	Ausführung, Material description, material	
50753	1 St.	grau grey	erleichtert die Ausrichtung des doppelten Rahmenprofils bei der Eckverbindung an das Options-Profil 47 + 78 facilitates the alignment of the double frame profile for the corner connection to the option profile 47 + 78	Kunststoff · plastic

Schraubendreher für Innensechskant Screwdriver for hexagon socket

Nr. no.	VE PU	Länge length	Ausführung description
12419	1 St.	100 mm	für Innensechskant Größe 2 mm for hexagon socket size 2 mm
12420	1 St.	100 mm	für Innensechskant Größe 2,5 mm for hexagon socket size 2,5 mm
12421	1 St.	100 mm	für Innensechskant Größe 3 mm for hexagon socket size 3 mm

Eckverbinder für Bilderrahmen Corner connector for picture frames

Nr. no.	VE PU	Breite width	Höhe height	Länge length	Ausführung, Material description, material
50624	1 / 20 St.	14,5 mm	75 mm	75 mm	Passend für doppeltes Bilderrahmenprofil Art.-Nr. 50622, Stahl verzinkt Fits for profil art. 50622, steel zinc plated

Verstärkungsstrebe für 90° Eckverbindung Reinforcing strut for 90° corner connection

Nr. no.	Ausführung, Material description, material
50731	Alu blank, inkl. 2 Nutensteine und Schrauben, zur Befestigung in der Innen-Nut des Bilderrahmenprofils · incl. 2 sliding blocks and screws, for fastening in the inner groove of the picture frame profile

Eckverbinder zum Verbinden von Rahmen 90°

Corner connector to connect frames 90°

	Nr. no.	VE PU	Breite width	Höhe height	Länge length	Ausführung, Material description, material
	50634	1 St.	30 mm	120 mm	120 mm	inkl. Nutensteine und Schrauben, Verbindung der Rahmen erfolgt über die Außen-Nut · incl. sliding blocks and screws, the frames are connected via the external groove

Gerader Verbinder zum Verbinden von Rahmen 180°

Straight connector to connect frames 180°

	Nr. no.	VE PU	Breite width	Länge length	Ausführung, Material description, material
	50635	1 St.	30 mm	170 mm	inkl. Nutensteine und Schrauben, Verbindung der Rahmen erfolgt über die Außen-Nut · incl. sliding blocks and screws, the frames are connected via the external groove

Verbinder für Cube 65

Connector for Cube 65

	Nr. no.	VE PU	Farbe colour	Ausführung, Material description, material
	50582	1 St.	grau grey	Eckverbinder für Profil tecosign cube 65, Kunststoff · corner connector for profile tecosign cube 65, plastic
	50583	1 St.	grau grey	gerader Verbinder für Profil tecosign cube 65, Kunststoff · connector straight for profile tecosign cube 65, plastic

Zargenschloss

Frame lock

	Nr. no.	VE PU	Breite width	Höhe height	Länge length	Ausführung, Material description, material
	50526	1 St.	16 mm	14 mm	46 mm	zur Befestigung der Verstärkungsprofile 50651/50652 an Bilderrahmenprofilen, Aluminium · for fastening reinforcement profiles 50651/50652 to picture frames, aluminium
	50672	1 St.	25 mm	14 mm	46 mm	zur Befestigung der Verstärkungsprofile 50332/50380 an Bilderrahmenprofilen, Aluminium · for fastening reinforcement profiles 50332/50380 to picture frames, aluminium
	50772	1 St.	57 mm	20 mm	54 mm	flexibles Zargenschloss, zum Beispiel verwendbar im Würfelprofil Cube 65, Kunststoff grau · Flexible frame lock, can be used in the Cube 65 profile, grey plastic

Wandhalter für Bilderrahmen, einfach

Wall holder for picture frames, single-sided

	Nr. no.	VE PU	Breite width	Länge length	✱	Ausführung, Material description, material
	50347	1 St.	30 mm	20 mm	2 mm	für Profil „Multi“, Eisen verzinkt · for profile „Multi“, iron galvanized
	50542	1 St.	40 mm	40 mm	4 mm	für Profile 50484 + 50570 + 50524, Aluminium · for profiles 50484 + 50570 + 50524, aluminium
	50756	1 St.	49 mm	40 mm	4 mm	für Profil „Multi“, Kunststoff · for profile „Multi“, plastic
	50755	1 St.	40 mm	37 mm	4 mm	für Profil „Tecosign 85“, Kunststoff · for profile „Tecosign 85“, plastic

Wandhalter für Bilderrahmen, doppelt Wall holder for picture frames, double-sided



Nr. no.	VE PU	Breite width	Länge length	*	Ausführung, Material description, material
50628	1 St.	40 mm	40 mm	4 mm	für doppelte Bilderrahmen 50485 + 50540 + 50625 + 50726, Aluminium · for double sided frames 50485 + 50540 + 50625 + 50726, aluminium

Pilz-Flachkeder Mushroom-type flat keder



Nr. no.	VE PU	Ausführung, Material description, material
50486	200 lfm	für kederloses Bespannen von Bilderrahmenprofilen, PVC for tensioning picture frame profiles without a keder, PVC

Flachkeder zum Bespannen von Bilderrahmen Flat keder for tensioning picture frames



Nr. no.	VE PU	Breite width	Höhe height	Ausführung, Material description, material
50396	200 lfm	11.6 mm	2.7 mm	63 shore, mit Rillen perforiert, PVC 63 shore, perforated with grooves, PVC
50256	200 lfm	12 mm	3 mm	70 shore, PVC · 70 shore, PVC
50304	200 lfm	12 mm	3 mm	70 shore, mit Rillen perforiert, PVC 70 shore, perforated with grooves, PVC
50175	200 lfm	14 mm	3 mm	70 shore, PVC · 70 shore, PVC
50394	200 lfm	14 mm	3 mm	80 shore - harte Ausführung, PVC 80 shore - heavy duty design, PVC
50300	100 lfm	14 mm	3 mm	Silikon · silicone
50636	50 lfm	14 mm	3 mm	70 shore - selbstklebend, PVC 70 shore, - self-adhesive, PVC
50632	200 lfm	14 mm	3 mm	67 shore, recyclbar mit silikonähnlichen Eigenschaften, PP · 67 shore, recyclable with silicone-like properties, PP
50633	200 lfm	14 mm	3 mm	65 shore, flexibel, PVC · 65 shore, flexible, PVC

Stick3 Kunststoff-Eindrückprofil Stick3 plastic crimping profile



Nr. no.	VE PU	Länge length	Farbe colour	Ausführung · description
50457	1 / 20 St.	2 m	weiß white	für kederloses Bespannen von Bilderrahmen- profilen · for tensioning picture frames without a keder
50460	1 lfm	lfm.		für kederloses Bespannen von Bilderrahmen- profilen, inkl. Gehrungsschnitt, fertig konfek- tioniert · for tensioning picture frames without a keder, incl. mitre cut, cut to size

Rakel Squeegee



NR. no.	VE PU	Ausführung · description	Videoanleitung instruction video
50458	1 St.	Rakel für stick3-Eindrückprofil Squeegee for stick3 crimping profile	

Keder-Ziehband Keder-Drawstring



Nr. no.	VE PU	Breite	Farbe	Ausführung, Material description, material
50575	200 lfm	5 mm	weiß white	stabiles, transparentes Band, es erleichtert das Herausziehen des Prints aus dem Rahmen, 100% PES · stable, transparent belt, facilitating the removal of prints from the frame, 100% PES

Standfuß für Bilderrahmen Base for picture frames



Nr. no.	VE PU	Breite width	Höhe height	Länge length	Gewicht weight	Farbe	Material material
50378	1 St.	60 mm	15 mm	370 mm	2.8 kg	silber silver	Stahl pulverbeschichtet steel powder-coated

Standfuß für Bilderrahmen, Base for picture frames



Nr. no.	VE PU	Breite width	Höhe height	Länge length	Gewicht weight	Farbe	Material material
50467	1 St.	80 mm	5 mm	300 mm	0.9 kg	silber silver	Stahl pulverbeschichtet steel powder-coated

Standfuß für Bilderrahmen Base for picture frames



Nr. no.	VE PU	Breite width	Höhe height	Länge length	Gewicht weight	Farbe	Material material
50531	1 St.	300 mm	8 mm	600 mm	11 kg	silber silver	Stahl pulverbeschichtet steel powder-coated

Standfuß für Bilderrahmen Base for picture frames



Nr. no.	VE PU	Breite width	Höhe height	Länge length	Gewicht weight	Farbe	Material material
50539	1 St.	80 mm	6 mm	500 mm	1.85 kg	silber silver	Stahl pulverbeschichtet steel powder-coated

Standfuß für Bilderrahmen Base for picture frames



Nr. no.	VE PU	Höhe height	Ø mm	Gewicht weight	Farbe	Material · material
50508	1 St.	6 mm	300 mm	3 kg	silber silver	Stahl pulverbeschichtet steel powder-coated

SILENTSYSTEM

Silentsystem ist ein schalldämmendes Akustiksystem, welches den Geräuschpegel in Räumen merkbar sinken lassen kann. Silentsystem ist freistehend oder als Wandausführung möglich. In Verbindung mit den entsprechenden Motiven ergibt sich ein dekoratives Wand- und Deckenakustiksystem. Für eine effektive Ausstattung des Raumes ist eine Berechnung der einzusetzen- den Flächen ratsam. Die Starke-Fachleute stehen Ihnen gerne mit einer Empfehlung zur Seite.

Silentsystem is a sound-absorbing acoustic system conceived to noticeably reduce noise levels in rooms. Silentsystem is available in free-standing or wall-mounted design. Combined with the appropriate decorative motifs, silentsystem is a visually appealing acoustic solution for walls and ceilings. For optimum efficiency, the surface area to be covered should be carefully planned and calculated. The Starke specialists will be happy to assist you with to-the-point advice!

Für den Bau eines Silentsystems benötigen Sie lediglich unsere Bilderrahmenprofile (S. 15 und S. 16) in einfacher Ausführung zur Decken-oder Wandmontage oder für freistehende Systeme die doppelten Bilderrahmensysteme mit entsprechenden Standfüßen (S. 24). Der Akustikstoff (Vlies), Art. 50676, aus schwer entflammarem Material wird in das Profil geklemmt und die mit Flachkedern (S. 64) ausgestatteten Druckmotive (aus sehr offenen Textilien oder PVC-Mesh) in die Profilvernut gedrückt.

All you need to create YOUR silentsystem is our picture frame profiles (p. 15 and p. 16) either in single-sided design (for ceiling and wall intallation) or in double-sided design with supporting feet (for free-standing systems, p. 24). The (non-woven) acoustic fabric (Art. 50676) made of flame-retardant material is clipped into the profile, and the print motifs (consisting of open-weave textile or PVC mesh material), which come with a flat keder (p. 64), are simply pressed into the profile groove.



Akustikstoff Vlies, schwer entflammbar Acoustic Fleece, flame retardant



Nr. no.	VE PU	✱	□	Farbe colour	Ausführung · description
50676	1 St.	30 mm	1200 x 800 mm	weiß white	schwer entflammbar, 100 % PES. 900 g/m ² flame retardant, 100 % PES. 900 g/m ²

Halter für Schallschutzmatte 20-30 mm Holder for sound insulation mats 20-30 mm



Nr. no.	VE PU	Farbe colour	Ausführung, Material description, material
50695	2 St.	weiß white	als Halterung für Akustik-Platten in Bilderrahmen-Systemen, für Breite 20 - 30 mm, Kunststoff, inkl. Nutensteine + Feststellschrauben as a holder for acoustic panels in picture frame systems, for width 20 - 30 mm, plastic, incl. sliding blocks + locking screws

LED-LIGHTBOX

Innovative Rahmensysteme für Ihre erfolgreiche Präsentation durch intensive und schattenfreie Bildwirkung. Für homogenen Glanz sorgen hochwertige LEDs, deren Lichtwinkel exakt aufeinander abgestimmt werden. Durch seine flexible Kombinierbarkeit eignen sich diese energieeffizienten, wartungsfreien Rahmensysteme ideal zur Wandmontage, Wandeinbau und Deckenabhängungen.

Innovative frame systems ensuring your presentation success thanks to intensive and shadowless picture illumination. The high-quality LEDs used are designed to deliver consistent performance, with homogeneous gloss and a precisely matched lighting angle. Due to their outstanding compatibility, these energy-efficient, maintenance-free frame systems are ideal not only for on-wall and in-wall mounting, but also for ceiling suspension.

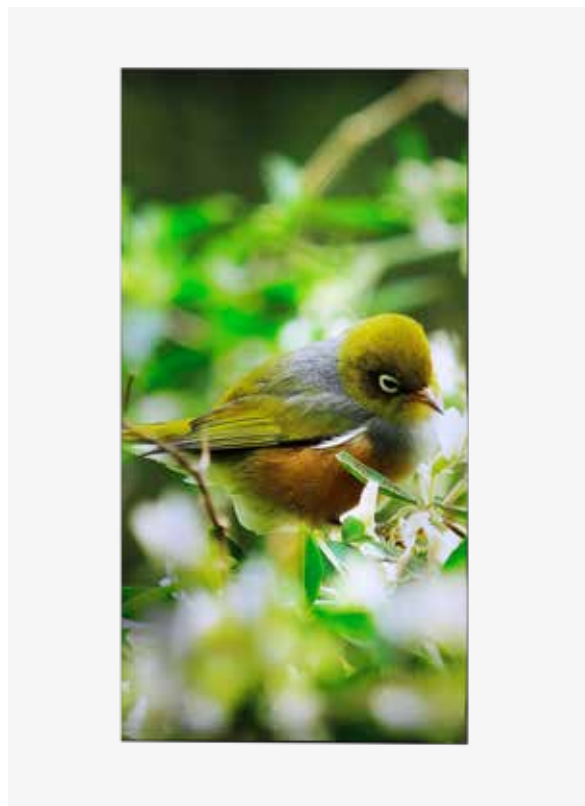

Pop-Up LED Box Pop-Up LED Box



Nr. no.	VE PU	Bildmaß picture dimension	Material · material	Ausführung description
50675	1 St.	1000 x 2000 mm	Aluminium aluminium	Auf- und abgebaut innerhalb von weniger Minuten durch ein geniales Stecksystem, völlig ohne Werkzeug montierbar, Lieferung ohne Spannbanner, LED-Farbe: 5000 - 7000 K Assembled and dismantled within a few minutes thanks to an ingenious plug-in system, can be mounted completely without tools, delivery without tension banner, LED colour: 5000 - 7000 K

LED Leuchtrahmen, Bautiefe 55 mm einseitig LED lightbox, 55 mm single-sided



Nr. no.	VE PU	Breite width	Höhe height	Länge · length	Material · material
50703	1 St.	55 mm	23 mm	auf Ihr Bildmaß zugeschnitten tailored to your picture size	Alu eloxiert aluminium anodised

LED Leuchtrahmen, Bautiefe 70 mm einseitig LED lightbox, 70 mm single-sided

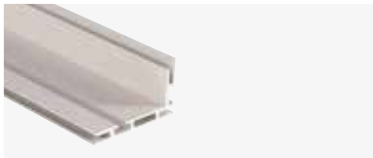

Nr. no.	VE PU	Breite width	Höhe height	Länge · length	Material · material
50704	1 St.	70 mm	40 mm	auf Ihr Bildmaß zugeschnitten tailored to your picture size	Alu eloxiert aluminium anodised

LED Leuchtrahmen, Bautiefe 85 mm einseitig, schwarz, pulverbeschichtet LED lightbox, 85 mm single-sided, black powder coated



Nr. no.	VE PU	Breite width	Höhe height	Länge · length	Material · material
50746	1 St.	85 mm	40 mm	auf Ihr Bildmaß zugeschnitten tailored to your picture size	Alu pulverbeschichtet, schwarz Powder-coated, aluminium, black

LED Leuchtrahmen, Bautiefe 100 mm einseitig LED lightbox, 100 mm single-sided



Nr. no.	VE PU	Breite width	Höhe height	Länge · length	Material · material
50705	1 St.	100 mm	49 mm	auf Ihr Bildmaß zugeschnitten tailored to your picture size	Alu eloxiert aluminium anodised

LED Leuchtrahmen, Bautiefe 120 mm einseitig LED lightbox, 120 mm single-sided



Nr. no.	VE PU	Breite width	Höhe height	Länge · length	Material · material
50706	1 St.	120 mm	39 mm	auf Ihr Bildmaß zugeschnitten tailored to your picture size	Alu eloxiert aluminium anodised

LED Leuchtrahmen, Bautiefe 100 mm doppelseitig LED lightbox, 100 mm double-sided



Nr. no.	VE PU	Breite width	Höhe height	Länge · length	Material · material
50707	1 St.	100 mm	14 mm	auf Ihr Bildmaß zugeschnitten tailored to your picture size	Alu eloxiert aluminium anodised

Preis auf Anfrage, schicken Sie uns gerne Ihre Wunsch-Formate für ein Angebot.
Price on request, please send us your desired size for a quote.

WOOD.STOCK

Die erste echte Alternative zu Bilderrahmen-Spannsystemen aus Aluminiumprofilen ist echtes Holz. Mit dem neuen Programm wood.stock eröffnen sich völlig neue Gestaltungsmöglichkeiten. Mit nur wenigen Handgriffen wird Ihr Motiv perfekt in Szene gesetzt. Wählen Sie zwischen zwei Farbtönen und drei Standardgrößen.

The first real alternative to tension frame systems made of aluminium profiles is genuine wood! The new wood.stock series opens up whole new design avenues.

In just a few simple steps, your motif is moved into the limelight where it belongs. You can choose between two different colours and three standard sizes.



wood.stock kann zur Verbesserung der Raumakustik mit silentsystem ausgestattet werden.

wood.stock can be equipped with silentsystem to enhance room acoustics.

Bilderrahmen „wood.stock“
Picture frame „wood.stock“



Nr. no.	VE PU	□	Ausführung, Material description, material
50476	1 St.	1100 x 2100 mm	für sichtbares Motivmaß: 1000 x 2000 mm, Motiv-Produktionsmaß: 1028 x 2028 mm, Eiche natur visible motif dimensions: 1000 x 2000 mm, motif production dimensions: 1028 x 2028 mm, natural oak
50477	1 St.	941 x 1289 mm	für sichtbares Motivmaß: DIN A0 (841 x 1189 mm), Motiv-Produktionsmaß: für DIN A0 (869 x 1217 mm), Eiche natur visible motif dimensions: DIN A0 (841 x 1189 mm), motif production dimensions: for DIN A0 (869 x 1217 mm), natural oak
50478	1 St.	694 x 941 mm	für sichtbares Motivmaß: DIN A1 (594 x 841 mm), Motiv-Produktionsmaß: für DIN A1 (622 x 869 mm), Eiche natur visible motif dimensions: DIN A1 (594 x 841 mm), motif production dimensions: for DIN A1 (622 x 869 mm), natural oak
50479	1 St.	1100 x 2100 mm	für sichtbares Motivmaß: 1000 x 2000 mm, Motiv-Produktionsmaß: 1028 x 2028 mm, Eiche wengefarben visible motif dimensions: 1000 x 2000 mm, motif production dimensions: 1028 x 2028 mm, Oak wenge colour
50480	1 St.	941 x 1289 mm	für sichtbares Motivmaß: DIN A0 (841 x 1189 mm), Motiv-Produktionsmaß: für DIN A0 (869x1217 mm), Eiche wengefarben visible motif dimensions: DIN A0 (841 x 1189 mm), motif production dimensions: for DIN A0 (869 x 1217 mm), Oak wenge colour
50481	1 St.	694 x 941 mm	für sichtbares Motivmaß: DIN A1 (594 x 841 mm), Motiv-Produktionsmaß: für DIN A1 (622 x 869 mm), Eiche wengefarben visible motif dimensions: DIN A1 (594 x 841 mm), motif production dimensions: for DIN A1 (622 x 869 mm), Oak wenge colour



**WANDABSPANN-
SYSTEME
WALL SUSPENSIONS
SYSTEMS**

QUICK IN

Präsentation mit sichtbaren oder verdeckten Profilen

Mittels Keder (Ø 7,5 - 10 mm) oder Hohlraum mit Stab spannen Sie Ihren Werbedruck faltenfrei an jede Wand. Den innovativen, Starke-Wandhalter (je max. 2 cm Spannweg oben und unten) montieren (ein Wandhalter je Meter), das Profil mit Druck einfach einhängen und mit Inbus-/ Sechskantschlüssel spannen – eine kinderleichte Montage.

- elegante, hochwertige Präsentation für In- und Outdoor
- extrem leichte und schnelle Montage
- einfaches Einhängen und Abspannen
- sichtbares oder verdecktes Profil
- verdeckte Halterungen

Design with visible profiles or concealed profiles

A keder (Ø 7,5 - 10 mm) or a rod passing through a hemstitch edge will reliably help you to attach your publicity print any wall without the slightest creasing or wrinkling of the print to be displayed. Just install the innovative Starke wall bracket (which has a tensioning distance of 2 cm each at the top and bottom) using one wall bracket per metre and press the profile in, then tension it with an allen wrench/hexagon wrench – that's it and you are done.

- elegant, high-quality display solution suitable for indoor and outdoor use
- neat and easy installation
- easy attachment and removal
- visible or concealed profile
- concealed brackets



QUICK IN-System QUICK IN-system

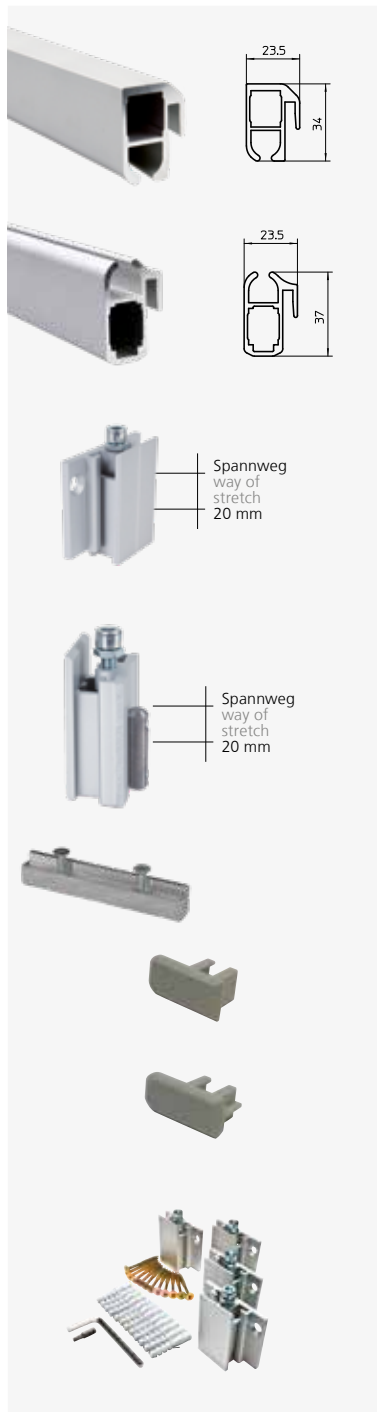

Nr. no.	VE PU	Breite width	Höhe height	Länge length	Farbe colour	Ausführung, Material description, material
50313	1 / 12 St.	23,5 mm	34 mm	6.05 m		Alukederschiene QUICK IN, für Ø 7 - 10 mm Keder, Alu eloxiert · aluminium keder rail QUICK IN, für Ø 7 - 10 mm keder, aluminium anodised
50314	1 / 12 St.	23,5 mm	37 mm	6.05 m		Alukederschiene QUICK IN, verdeckte Version , für Ø 7 - 10 mm Keder, Alu eloxiert · aluminium keder rail QUICK IN, concealed version , for Ø 7 - 10 mm keders, aluminium anodised
50315	1 St.	76 mm	60 mm			Wandhalter QUICK IN, zum Abspannen von Bannern mit der QUICK IN Kederschiene an Wänden, 2 tlg. Inkl. Kontermutter, Alu eloxiert for tensioning of banners with QUICK IN keder rails on wall, 2-piece design incl. locknut, aluminium anodised
50327	1 St.	76 mm	60 mm			Profilhalter QUICK IN, zum Abspannen von Bannern mit der QUICK IN Kederschiene an Vierkanal-Kederprofilen, 2 tlg. Inkl. Kontermutter, Alu eloxiert · for tensioning of banners with QUICK IN keder rails on 4-channel keder rails, 2-piece design incl. locknut, aluminium anodised
50318	1 St.					Verbindungsachse für Alu-Profile QUICK IN, Alu blank · connector for aluminium profiles TECOSIGN QUICK IN, aluminium bare
50316	1 St.				grau grey	Endkappe für Alu-Profile für Alu-Profile QUICK IN, Kunststoff · end cap for aluminium profiles QUICK IN, plastic
50317	1 St.				grau grey	Endkappe für Alu-Profile QUICK IN, verdeckte Version , Kunststoff · end cap for aluminium profiles QUICK IN, concealed version , plastic
50423	1 Set					Montageset, bestehend aus 4 Wandhaltern, 12 Torxschrauben 6 x 60 mm inkl. Dübeln, 1 Bit, 1 Inbusschlüssel, Alu eloxiert mounting kit, comprised of 4 wall comprised of 4 wall brackets, 12 Torx screws 6 x 60 mm incl. dowels, 1 bit, 1 Allen key, aluminium anodised

Das Spannsystem QUICK IN kann nicht nur an Wänden befestigt werden, sondern auch an Vierkanalprofilen.
The QUICK IN tensioning system can be fitted not only to walls, but also to 4-channel profiles.

Direkt zur Videoanleitung:
Your direct link to the instruction video:



verdeckte Profile
concealed profiles



sichtbare Profile
visible profiles

Alukederschiene 17 x 44 mm Aluminium keder rail 17 x 44 mm

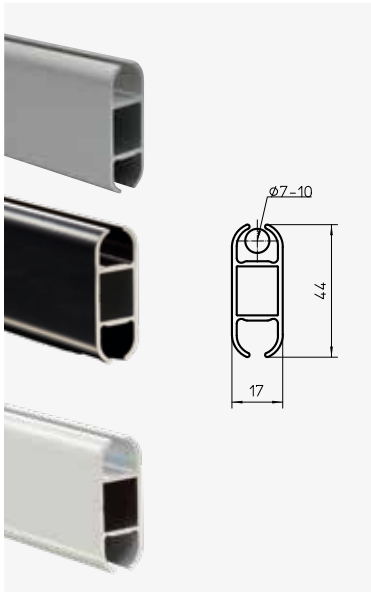

Nr. no.	VE PU	Breite width	Höhe height	Länge length	Farbe colour	Material · material
50064	1 / 12 St.	17 mm	44 mm	2.55 m		Alu blank · aluminium bare
50062	1 / 12 St.	17 mm	44 mm	6.05 m		Alu blank · aluminium bare
50065	1 / 12 St.	17 mm	44 mm	2.55 m		Alu eloxiert aluminium anodised
50008	1 / 12 St.	17 mm	44 mm	3.50 m		Alu eloxiert aluminium anodised
50015	1 / 12 St.	17 mm	44 mm	6.05 m		Alu eloxiert aluminium anodised
50259	1 / 12 St.	17 mm	44 mm	6.05 m	weiß white	Alu pulverbeschichtet aluminium powder-coated
50258	1 / 12 St.	17 mm	44 mm	6.05 m	schwarz black	Alu pulverbeschichtet aluminium powder-coated

Profilhalter mit Langloch Profile holder with long slot



Nr. no.	VE PU	Breite width	Höhe height	Länge length	Material material
50028	1 / 20 St.	50 mm	83 mm	42 mm	Edelstahl · stainless steel
50455	1 / 20 St.	50 mm	95 mm	42 mm	Alu eloxiert · aluminium anodised

Zur Wandmontage von Alukederschiene.
For wall mounting of aluminium keder rails.

Wandhalter „indoor“ Wall holder „indoor“

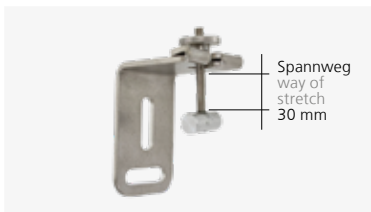

Nr. no.	VE PU	Breite width	Höhe height	Länge length	→	Ausführung, Material description, material
50060	1 / 20 St.	40 mm	66 mm	45 mm	30 mm	zum Abspannen von Drucken mittels Kederschiene im Innenbereich, Edelstahl for tensioning banners/prints with keder rails in indoor areas, stainless steel

Wandhalter „strong“ Wall holder „strong“

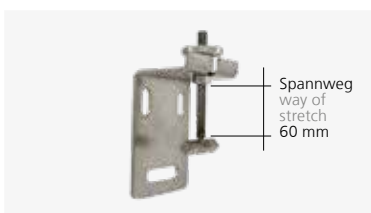

Nr. no.	VE PU	Breite width	Höhe height	Länge length	→	Ausführung, Material description, material
50112	1 / 20 St.	70 mm	93 mm	48 mm	60 mm	zum Abspannen von Drucken mittels Kederschiene im Außenbereich, Edelstahl for tensioning banners/prints with keder rails in outdoor areas, stainless steel

Wandhalter
Wall holder

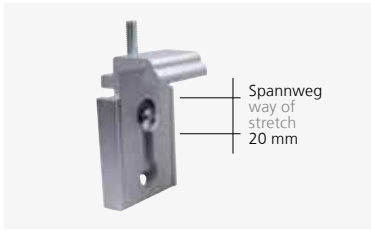

Nr. no.	VE PU	Breite width	Höhe height	Länge length	→	Ausführung, Material description, material
50209	1 / 20 / 100 St.	60 mm	70 mm	40 mm	20 mm	2-teilig, zum Abspannen von Drucken im Innen- und Außenbereich, Alu eloxiert 2-piece design, for tensioning banners/prints with keger rails in indoor or outdoor areas, aluminium anodised

Wandhalter Montageset (neutrale Verpackung)
Wall holder mounting kit (neutral packaging)



Nr. no.	VE PU	Ausführung · description
50420	1 Set	bestehend aus 4 Wandhaltern, 12 Torxschrauben 6 x 60 mm, inkl. Dübeln, 1 Bit und Inbusschlüssel, Alu eloxiert comprised of 4 wall brackets, 12 Torx screws 6 x 60 mm, incl. dowels, 1 bit, 1 Allen key, aluminium anodised

Profilhalter
Profile holder



Nr. no.	VE PU	Breite width	Höhe height	Ausführung · description
50465	1 St.	50 mm	70 mm	Alu eloxiert, zur Montage an Vierkanalprofilen (Ø 50 mm), 2-teilig, Alu eloxiert · aluminium anodised, for fitting to 4-channel profiles (Ø 50 mm), 2-piece design, aluminium anodised

Abstandshalter für Wandhalter 50209 und 50315
Spacer for wall holder 50209 and 50315



Nr. no.	VE PU	Ausführung, Material description, material
50527	1 St.	zur Überbrückung von Wandvorsprüngen, Wandabstand: 215 mm, Stahl feuerverzinkt · for bridging wall projections, wall distance: 215 mm, steel galvanised

Abspannvorrichtung, 6-teilig Tensioning fixture, 6-pieces

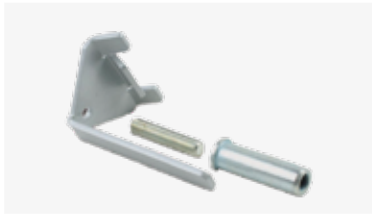

Nr. no.	VE PU	Ausführung, Material description, material
50203	1 / 10 Satz	zum Abspannen von Profilen (in Verbindung mit Alukederprofil 15 x 30 mm) inkl. je 2 Spannstücke, Gewindestücke, Gewindestifte, Stahl verzinkt/silber, pulverbeschichtet for tensioning profiles (in combination with aluminium keder profile 15 x 30 mm). composed of: 2x clamping pieces, 2x thread pieces, 2x grub screws, zinc plated steel/silver, powder coated

In Verbindung mit Alukederprofil 15 x 30 mm.
In combination with aluminium keder profile 15 x 30 mm.

Befestigungswinkel Fastening Angle

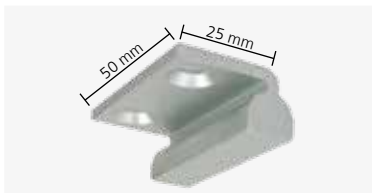

Nr. no.	VE PU	Ausführung, Material description, material
50449	1 / 20 St.	zur Boden- und Deckenbefestigung von Alukederschienen, Maße der Grundplatte 25 x 50 mm, Alu eloxiert · for floor and ceiling mounting of aluminium keder rails, dimensions of the base plate 25 x 50 mm, aluminium anodised

Profilhalter Profile holder



Nr. no.	VE PU	Ausführung, Material description, material
50007	1 / 20 St.	zur Wandmontage von Alukederschienen, Stahl verzinkt for wall mounting of aluminium keder rails, steel zinc plated

Profilhalter Profile holder



Nr. no.	VE PU	Ø	Ausführung, Material description, material
50125	1 / 20 St.	30 mm	zur horizontalen und vertikalen Wandmontage von Alukederschiene Ø 30 mm, Aluminium for horizontal and vertical wall mounting of aluminium keder rails Ø 30 mm, aluminium



SEILSYSTEME CABLE SYSTEMS

Wandhalter Wall holder

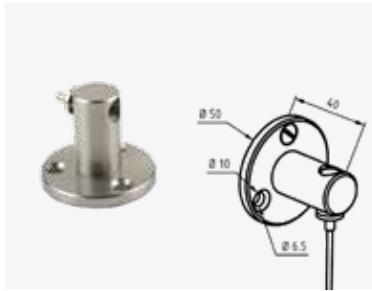

Nr. no.	VE PU	Ø	Ausführung, Material description, material
50169	1 / 10 St.	20 mm	mit Flansch und Seilspanner (zum Abspannen von Seilkonstruktionen), Stahl vernickelt · with flange and rope tensioner (for tensioning of cable structures), nickel-plated steel

Wandhalter Wall holder

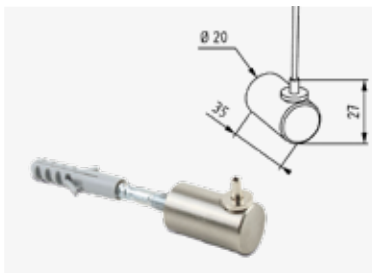

Nr. no.	VE PU	Ø	Ausführung, Material description, material
50170	1 / 10 St.	20 mm	zum Spannen von leichten Seilkonstruktionen an Wänden und Decken, mit Stockschraube, Stahl vernickelt for tensioning of lightweight cable structures on walls and ceilings, with stock screw, nickel-plated steel

Boden- & Deckenhalter mit Flansch Floor- & ceiling holder with flange

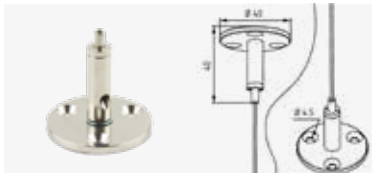

Nr. no.	VE PU	Ausführung, Material description, material
50056	1 / 10 St.	mit seitlichem Seilausgang zum Nachspannen von Ø 1.5 mm Stahlseile, Messing vernickelt · with lateral cable exit for retensioning of Ø 1.5 mm steel cables, brass nickel plated

Boden- & Deckenhalter Floor- & ceiling holder



Nr. no.	VE PU	Ausführung, Material description, material
50010	1 / 10 St.	mit seitlichem Seilausgang zum Nachspannen von Ø 1.5 mm Stahlseile, Messing vernickelt · with lateral cable exit for tensioning of Ø 1.5 mm steel cables, brass nickel plated

Plattenhalter mit Seilspanner Panel holder with cable tensioner

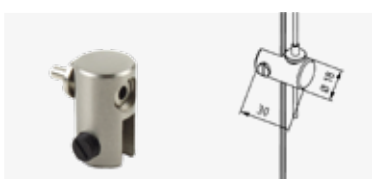

Nr. no.	VE PU	Ausführung, Material description, material
50154	1 / 10 St.	zum Halten von Platten bis 6 mm in Kombination mit Edelstahlseilen, Stahl vernickelt · for holding of max. 6 mm panels in combination with INOX cables, nickel-plated steel

Seilstopper für 1,5 mm Seile mit Schlitz
Cable stopper for 1,5 mm cables with slot



Nr. no.	VE PU	Ausführung, Material description, material
50532	1 / 20 St.	zum Abhängen von Platten bis 4 mm mit Seilaustritt zum Nachspannen von Ø 1.5 mm Stahlseile, Messing vernickelt for hanging up of panels up to 4 mm with cable exit for tensioning of Ø 1.5 mm steel cables, brass nickel plated

Schiengleiter, mit Rundgleiter
Rail slider, with round glider



Nr. no.	VE PU	Ausführung, Material description, material
50033	1 / 20 St.	zum Abhängen von Alukederschienen mit Seilaustritt zum Nachspannen von Ø 1.5 mm Stahlseile, TÜV zertifiziert, Alu/Messing vernickelt · for hanging up of aluminium keder rails with cable exit for tensioning of Ø 1.5 mm steel cables, TÜV certified, aluminium/nickel plated brass
50713	1 / 10 St.	mit Rändelmutter und Seilaustritt zum Nachspannen von Ø 3.0 mm Stahlseile - mit Werkzeugschein vom Hersteller -, Alu/Messing vernickelt · with knurled nut and rope outlet for re-tensioning Ø 3.0 mm steel cables - with manufacturer's certificate -, aluminium/nickel plated brass

Schiengleiter mit Stahlplättchen, Alu, Messing vernickelt
Rail slider with steel plates, aluminium, nickel plated brass



Nr. no.	VE PU	Ausführung, Material description, material
50350	1 / 20 St.	mit Seilaustritt zum Nachspannen von Ø 1.5 mm Stahlseile, TÜV zertifiziert, Alu/Messing vernickelt · with rope outlet for re-tensioning Ø 1.5 mm steel ropes, TÜV certified, aluminium/nickel plated brass
50714	1 / 10 St.	mit Rändelmutter und Seilaustritt zum Nachspannen von Ø 3.0 mm Stahlseile, - mit Werkzeugschein vom Hersteller -, Alu/Messing vernickelt · with knurled nut and rope outlet for re-tensioning Ø 3.0 mm steel ropes, - with manufacturer's certificate -, aluminium/nickel plated brass

Schiengleiter mit Nutenstein
Rail slider with slot nut



Nr. no.	VE PU	Ausführung, Material description, material
50678	1 St.	zum Abhängen von Bilderrahmen, mit Außen-Nut, fixierbar mit Rändelmutter, TÜV zertifiziert, Messing vernickelt, für Ø 1.5 mm Stahlseile · for hanging picture frames, with external groove, fixable with knurled nut, TÜV certified, brass nickel plated, for Ø 1.5 mm steel ropes

Schienengleiter mit Gelenk Rail slider with hinge



Nr. no.	VE PU	Ausführung, Material description, material
50671	1 / 20 St.	zum Abhängen von Alukederschienen mit Seilaustritt zum Nachspannen von Ø 1.5 mm Stahlseile, mit Rändelmutter-Sicherung, mit Werkszeugnis vom Hersteller, Alu/Messing vernickelt · for hanging up of aluminium keeder rails with cable exit for retensioning of Ø 1.5 mm steel ropes, with lock nut, with manufacturer's certificate, aluminium/brass nickel plated

Loop Verbinder Loop connector



Nr. no.	VE PU	Ausführung, Material description, material
50669	1 / 10 St.	Zur schnellen Herstellung einer Seilschleife, ohne Werkzeug verwendbar, für Ø 1.5 mm Stahlseile, TÜV zertifiziert, Messing vernickelt · for quick production of a rope loop, can be used without tools, for Ø 1.5 mm steel ropes, TÜV certified, brass nickel plated
50677	1 / 10 St.	Zur schnellen Herstellung einer Seilschleife, ohne Werkzeug verwendbar, für Ø 3.0 mm Stahlseile, - mit Werkszeugnis vom Hersteller -, Messing vernickelt · for quick production of a rope loop, can be used without tools, for Ø 3.0 mm steel ropes, - with manufacturer's certificate -, brass nickel plated

Abhänge-Set für tecosign cube 65 Suspension set for tecosign cube 65



Nr. no.	VE PU	Ausführung · description
50655	2 St.	für Ø 1.5 mm Stahlseile, ein Satz besteht aus einer Halterung + Nutenstein, komplettieren können Sie die Halterung mit dem Schienengleiter Art. 50350, Stahl verzinkt · for Ø 1.5 mm steel ropes, one set consists of one bracket + sliding block, you can complete the holder with the rail glider Art. 50350, steel zinc plated

Nutenstein Slot nut

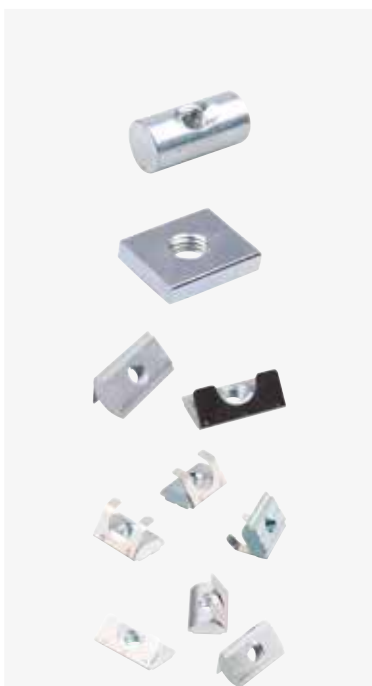

Nr. no.	VE PU	Ø	Ausführung, Material description, material
50034	1 St.	10 mm	Rundgleiter Ø 10 mm, mit M5-Gewinde für Alukederschienen, Aluminium · round slider Ø 10mm, with M5 thread for aluminium keeder rails, aluminium
50351	1 St.		Stahlplättchen 14 x 12 x 3 mm, M5 für Bilderrahmenprofile steel plates 14 x 12 x 3 mm, M5 for picture frame profiles
50573	1 St.		Nutenstein 10.8 x 4.1 x 20 mm, M5, einschwenkbar mit Federblech für Bilderrahmenprofile, Stahl verzinkt slot nut 10.8 x 4.1 x 20 mm, M5, swivelled with spring steel sheet for picture frame profiles, steel zinc plated
50574	1 St.		Nutenstein 11.6 x 4.6 x 16 mm, M5, einschwenkbar mit Federblech für Bilderrahmenprofile, Stahl verzinkt slot nut 11.6 x 4.6 x 16 mm, M5, swivelled with spring steel sheet for picture frame profiles, steel zinc plated
50591	1 St.		Nutenstein 10.8 x 4.1 x 20 mm, M6, einschwenkbar mit Federblech für Bilderrahmenprofile, Stahl verzinkt slot nut 10.8 x 4.1 x 20 mm, M6, swivelled with spring steel sheet for picture frame profiles, steel zinc plated

Ösenfeststeller, PVC weiss
 Eyelet arrester, PVC white

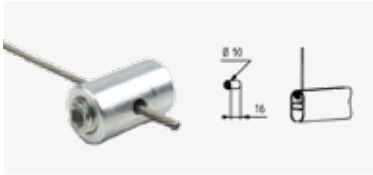

Nr. no.	VE PU	Farbe colour	Ausführung, Material description, material
50425	1 / 100 St.	weiß white	zum Abhängen von Alukederschienen, max. Hängelast ca. 5 kg, Kunststoff · for hanging up of aluminium keder rails, max. hang load ca. 5 kg, plastic

Seilhalter für Ø 1,5 mm Stahlseile
 Cable holder for Ø 1,5 mm steel ropes

Nr. no.	VE PU	Ausführung, Material description, material
50011	1 / 20 St.	zum Abhängen von Alukederschienen, Aluminium for hanging up of aluminium keder rails, aluminium

Kugelseilhalter für Ø 1,5 mm Stahlseile
 Ball-shaped cable holder for Ø 1,5 mm steel ropes

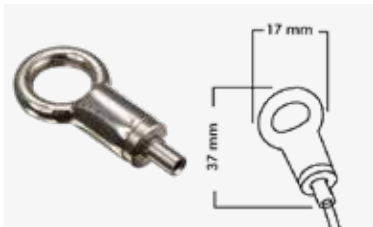
Nr. no.	VE PU	Ø	Ausführung, Material description, material
50325	1 / 20 St.	10 mm	zum Abhängen von Alukederschienen, Edelstahl for hanging up of aluminium keder rails, stainless steel

Öse mit Seilspanner
 Eyelet with cable tensioner

Nr. no.	VE PU	Ausführung, Material description, material
50052	1 / 20 St.	für Ø 1,5 mm Stahlseile, Messing vernickelt for Ø 1,5 mm steel ropes, brass nickel plated

Haken mit Seilspanner
 Hook with cable tensioner

Nr. no.	VE PU	Ausführung, Material description, material
50051	1 / 20 St.	für Ø 1,5 mm Stahlseile, Messing vernickelt for Ø 1,5 mm steel ropes, brass nickel plated

Öse mit Seilspanner

Eyelet with cable tensioner



Nr. no.	VE PU	Ausführung, Material description, material
50680	1 / 20 St.	für Ø 1.5 mm Stahlseile, TÜV zertifiziert , Messing vernickelt for Ø 1.5 mm steel ropes, TÜV certified , brass nickel plated

Haken mit Seilspanner

Hook with cable tensioner



Nr. no.	VE PU	Ausführung, Material description, material
50679	1 / 20 St.	mit Aushängesicherung, für Ø 1.5 mm Stahlseile, TÜV zertifiziert , Messing vernickelt · with safety catch, for Ø 1.5 mm steel ropes, TÜV certified , brass nickel plated

Ösenschraube

Eyelet screw



Nr. no.	VE PU	Ausführung, Material description, material
50032	1 / 100 St.	zum Abhängen von Alukederschienen, Stahl verzinkt/Aluminium for hanging up of aluminium keder rails, steel zinc plated/aluminium

Hakenschraube

Hook screw



Nr. no.	VE PU	Ausführung, Material description, material
50013	1 / 100 St.	zum Abhängen von Alukederschienen, Stahl verzinkt/Aluminium for hanging up of aluminium keder rails, steel zinc plated/aluminium

Spannschloss

Turnbuckle



Nr. no.	VE PU	Breite width	Länge length	Ausführung, Material description, material
50074	1 / 10 St.	6 mm	60 mm	zum Spannen von Seilkonstruktionen (Spannweg 60 mm), Stahl verzinkt for tensioning of cable constructsures (tension path 60 mm), steel zinc plated

Hakenschraube mit Dübel

Hook screw with dowel

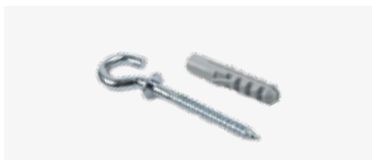

Nr. no.	VE PU	Ø	Länge length	Ausführung, Material description, material
50077	1 / 50 St.	14.5 mm	95 mm	zur festen Wand-/Decken- & Bodenbefestigung, Gewinde 5.8 x 60 mm, Stahl verzinkt for firm fastening on wall-/ceiling & floor mounting. thread 5.8 x 60 mm, steel zinc plated

Gewicht
Weight



Nr. no.	VE PU	Ø	Höhe height	Gewicht weight	Material · material
50057	1 St.	50 mm	40 mm	445 g	Stahl vernickelt · nickel-plated steel

Gewicht mit Seilspanner
Weight with cable tensioner



Nr. no.	VE PU	Ø	Höhe height	Gewicht weight	Ausführung, Material description, material
50058	1 St.	50 mm	40 mm	445 g	mit Seilstopper für Ø 1.5 mm Stahlseile, Stahl vernickelt with cable stopper for Ø 1.5 mm steel ropes, nickel-plated steel

Edelstahlseil
Inox cable



Nr. no.	VE PU	Ø	Länge length	Material · material
50021	100 lfm	1.5 mm	100 m	Edelstahl · stainless steel
50490	100 lfm	3 mm	100 m	Edelstahl · stainless steel

Edelstahlseil
Inox cable

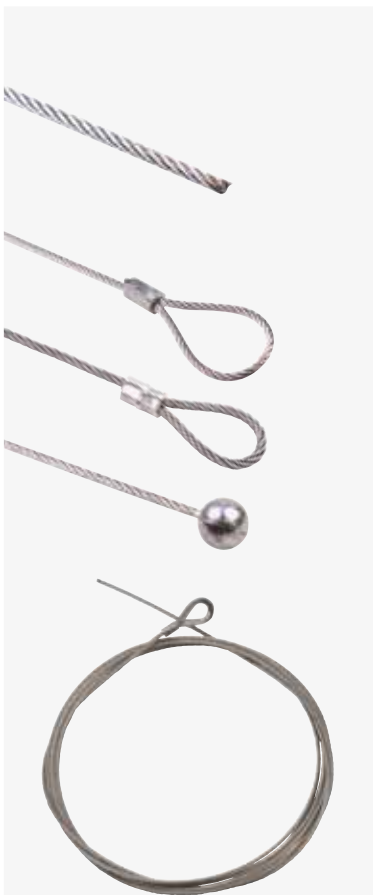

Nr. no.	VE PU	Ø	Länge · length	Ausführung, Material description, material
50022	1 / 10 St.	1.5 mm	500 mm Fixlänge	Edelstahl · stainless steel
50023	1 / 10 St.	1.5 mm	1500 mm Fixlänge	Edelstahl · stainless steel
50024	1 / 10 St.	1.5 mm	3000 mm Fixlänge	Edelstahl · stainless steel
50025	1 / 10 St.	1.5 mm	500 mm Fixlänge	mit 3 cm Schlaufe, Edelstahl with 3 cm loop, stainless steel
50026	1 / 10 St.	1.5 mm	1500 mm Fixlänge	mit 3 cm Schlaufe, Edelstahl with 3 cm loop, stainless steel
50027	1 / 10 St.	1.5 mm	3000 mm Fixlänge	mit 3 cm Schlaufe, Edelstahl with 3 cm loop, stainless steel
50702	1 / 10 St.	1.5 mm	5000 mm Fixlänge	mit 3 cm Schlaufe, Edelstahl with 3 cm loop, stainless steel
50551	1 / 5 St.	3 mm	1500 mm Fixlänge	mit 3 cm Schlaufe, Edelstahl with 3 cm loop, stainless steel
50552	1 / 5 St.	3 mm	3000 mm Fixlänge	mit 3 cm Schlaufe, Edelstahl with 3 cm loop, stainless steel
50674	1 / 5 St.	3 mm	5000 mm Fixlänge	mit 3 cm Schlaufe, Edelstahl with 3 cm loop, stainless steel
50282	1 / 10 St.	1.5 mm	500 mm Fixlänge	mit 8 mm Kugel, Edelstahl with 8 mm ball, stainless steel
50283	1 / 10 St.	1.5 mm	1500 mm Fixlänge	mit 8 mm Kugel, Edelstahl with 8 mm ball, stainless steel
50284	1 / 10 St.	1.5 mm	3000 mm Fixlänge	mit 8 mm Kugel, Edelstahl with 8 mm ball, stainless steel
50681	1 / 10 St.	1.5 mm	3000 mm Fixlänge	einseitige Schlaufe, mit Kausche verpresst, Edelstahl · loop on one side, pressed with thimble, stainless steel
50682	1 / 10 St.	3.0 mm	3000 mm Fixlänge	einseitige Schlaufe, mit Kausche verpresst, Edelstahl · loop on one side, pressed with thimble, stainless steel

Nylonseil Nylon cable



Nr. no.	VE PU	Ø	Farbe colour	
50072	100 lfm	1.5 mm	transparent transparent	

Seilklemme Cable clamp



Nr. no.	VE PU	Ausführung, Material description, material
50012	100 St.	zum Verpressen von Stahlseile Ø 1.5 mm, Aluminium for pressing steel ropes Ø 1.5 mm, aluminium
50523	100 St.	zum Verpressen von Stahlseile Ø 3.0 mm, Aluminium for pressing steel ropes Ø 3.0 mm, aluminium

Seilklemme für 3 mm Stahlseile Cable clamp for 3 mm steel cables



Nr. no.	VE PU	Material · material
50494	1 / 100 St.	Stahl verzinkt · steel zinc plated
50495	1 / 100 St.	Nirosta · INOX

Drahtseilschere Cable cutter



Nr. no.	VE PU	Ausführung · description
50079	1 St.	Drahtseilschere zum Ablängen von Edelstahlseilen wire rope cutter for easy shortening of INOX cable

Handpresszange Hand crimping plier



Nr. no.	VE PU	Ausführung · description
50053	1 St.	Handpresszange zum Verarbeiten von Seilklemmen für Edelstahlseile Ø 1.5 mm · hand crimping plier for easy pressing cable clamps for INOX cables Ø 1.5 mm



ZUBEHÖR

ACCESSORIES

Endkappe Kunststoff

End cap plastic

	Nr. no.	VE PU	Farbe colour	Ausführung, Material description, material
	50316	1 / 20 / 100 St.	grau grey	für Alu-Profile QUICK IN, Kunststoff for aluminium profiles QUICK IN, plastic
	50317	1 / 20 / 100 St.	grau grey	für Alu-Profile QUICK IN, verdeckt, Kunststoff for aluminium profiles QUICK IN, covert, plastic
	50019	1 / 20 / 100 St.	grau grey	für Alukederschiene 17 X 44 mm, Kunststoff for aluminium keder rails 17 x 44 mm, plastic
	50543	1 / 20 / 100 St.	weiß white	für Alukederschiene 17 x 44 mm, Kunststoff for aluminium keder rails 17 x 44 mm, plastic
	50544	1 / 20 / 100 St.	schwarz black	für Alukederschiene 17 x 44 mm, Kunststoff for aluminium keder rails 17 x 44 mm, plastic
	50135	1 / 20 / 100 St.	grau grey	für Alukederschiene 15 x 30 mm, Kunststoff for aluminium keder rails 15 x 30 mm, plastic
	50110	1 / 20 / 100 St.	weiß white	für Alukederschiene 15 x 30 mm, Kunststoff for aluminium keder rails 15 x 30 mm, plastic
	50545	1 / 20 / 100 St.	schwarz black	für Alukederschiene 15 x 30 mm, Kunststoff for aluminium keder rails 15 x 30 mm, plastic
	50020	1 / 20 / 100 St.	grau grey	für Alukederschiene Ø 30 mm, Kunststoff for aluminium keder rails Ø 30 mm, plastic
	50243	1 St.	grau grey	für 4-Kederschiene Ø 50 mm, Aluminium for 4-channel keder rails Ø 50 mm, aluminium
	50732	1 St.	grau/silber grey/silver	für tecosign Option 47, Kunststoff/Aluminium for tecosign option 47, plastic/aluminium
	50733	1 St.	grau/silber grey/silver	für tecosign Option 78, Kunststoff/Aluminium for tecosign option 78, plastic/aluminium
	50757	1 St.	grau/silber grey/silver	für tecosign Option 47, mit verstellbaren Fuß, Kunststoff/Aluminium for tecosign option 47, with adjustable foot, plastic/aluminium
	50758	1 St.	grau/silber grey/silver	für tecosign Option 78, mit verstellbaren Fuß, Kunststoff/Aluminium for tecosign option 78, with adjustable foot, plastic/aluminium

Verbindungsachse für Alukederprofile
Connectors for aluminium keder rails



Nr. no.	VE PU	Ø	Länge length	Ausführung, Material description, material
50001	1 / 10 St.	11 mm	140 mm	für Alukederschiene 17 x 44 mm, mit Verdrehschutz, Stahl verzinkt for aluminium keder rails 17 x 44 mm with anti-twist safeguard, steel zinc plated
50004	1 / 10 St.	12 mm	140 mm	inkl. Gewindestiften, Stahl verzinkt incl. grub screws, steel zinc plated
50742	1 / 10 St.	12 mm	140 mm	inkl. 4 Klemmschrauben, Kunststoff PA6 incl. grub screws, plastic PA6
50471	1 / 10 St.	12 mm	140 mm	inkl. Gewindestiften, passend für Alukederschiene (21 x 48 mm) Art. 50452, Stahl verzinkt incl. grub screws, fits for aluminium channel rail (21 x 48 mm) art. 50452, steel zinc plated

Verbindungsachse, für gebogene Alukederprofile
Connector for bent aluminium keder rails



Nr. no.	VE PU	Ø	Länge length	Ausführung, Material description, material
50176	1 / 10 St.	12 mm	140 mm	inkl. Gewindestiften, Stahl verzinkt incl. grub screws, steel zinc plated

Eckverbinder vertikal 90° STARR
Rail connector vertical 90° RIGID



Nr. no.	VE PU	Ø	Höhe height	Länge length	Ausführung, Material description, material
50511	1 St.	12 mm	85 mm	85 mm	inkl. Gewindestiften, Stahl verzinkt incl. grub screws, steel zinc plated

Flexverbinder vertikal
Flex connector vertical



Nr. no.	VE PU	Ø	Breite width	Höhe height	Ausführung, Material description, material
50006	1 / 10 St.	11 mm	74 mm	74 mm	inkl. Gewindestiften, Stahl verzinkt incl. grub screws, steel zinc plated

Flexverbinder horizontal
Flex connector horizontal



Nr. no.	VE PU	Ø	Breite width	Höhe height	Ausführung, Material description, material
50005	1 / 10 St.	11 mm	74 mm	74 mm	inkl. Gewindestiften, Stahl verzinkt incl. grub screws, steel zinc plated

Nutenwinkel Edelstahl

Grooves elbows inox

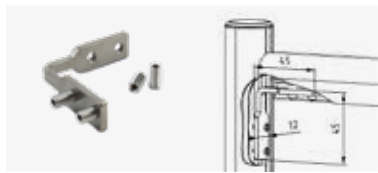

Nr. no.	VE PU	Breite width	Höhe height	Ausführung, Material description, material
50163	1 St.	45 mm	45 mm	inkl. Gewindestiften, Edelstahl incl. grub screws, stainless steel

Eckverbinder horizontal 90°, kurze Ausführung

Corner connector horizontal 90°, short version



Nr. no.	VE PU	Ø	Breite width	Höhe height	Ausführung, Material description, material
50691	1 St.	12 mm	64 mm	64 mm	inkl. Gewindestiften, Stahl verzinkt, für Queranbindungen und Eckverbindungen (in der innen liegenden Keder-Nut eingesetzt) · incl. grub screws, steel zinc plated, for cross connections and corner connections (inserted in the inner keder groove)

Eckverbinder horizontal 90°, lange Ausführung

Corner connector horizontal 90°, long version



Nr. no.	VE PU	Ø	Breite width	Höhe height	Ausführung, Material description, material
50693	1 St.	12 mm	83 mm	83 mm	inkl. Gewindestiften, Stahl verzinkt, für Eckverbindungen (in der äußeren Keder-Nut eingesetzt) · incl. grub screws, steel zinc plated, for corner connections (inserted in the outer keder groove)

Spannbarer Eckverbinder Aluguss

Tensible corner connector die-cast aluminium



Nr. no.	VE PU	Ausführung, Material description, material
50054	1 St.	für Alukederschiene Ø 30 mm, Aluguss for aluminium keder rail Ø 30 mm, cast aluminium
50201	1 St.	für Alukederschiene 17 x 44 mm, spannbar, Aluguss for aluminium keder rail 17 x 44 mm, tensible, cast aluminium

Zum Herstellen von Rahmenkonstruktionen.
For creating frame constructions.

Schelle Aluminium

Clamp aluminium



Nr. no.	VE PU	Ausführung, Material description, material
50080	1 St.	für Rohrtraversen Ø 49 - 51 mm, Aluminium for pipe trusses Ø 49 - 51 mm, aluminium

Querverbinder Aluguss

Cross connector die-cast aluminium



Nr. no.	VE PU	Ausführung, Material description, material
50055	1 St.	für Alukederschiene Ø 30 mm, Aluguss for aluminium keder rail Ø 30 mm, cast aluminium

Schelle mit Wandhalter „INDOOR“
Clamp with wall holder "INDOOR"

	Nr. no.	VE PU	Ausführung, Material description, material
	50567	1 St.	für Rohrtraversen Ø 49 - 51 mm, Aluminium for pipe trusses Ø 49 - 51 mm, aluminium

Winkelverbinder für 4-Kanal Kederschiene Ø 50 mm
Angle connector for 4-channel keder rail Ø 50 mm

	Nr. no.	VE PU	Material material
	50249	1 St.	Aluminium · aluminium

T-Verbinder für 4-Kanal Kederschiene Ø 50 mm
T-Connector for 4-channel keder rail Ø 50 mm

	Nr. no.	VE PU	Material material
	50250	1 St.	Aluminium · aluminium

Eckverbinder für 4-Kanal Kederschiene Ø 50 mm
Corner connector for 4-channel keder rail Ø 50 mm

	Nr. no.	VE PU	Material material
	50251	1 St.	Aluminium · aluminium

Kreuzverbinder für 4-Kanal Kederschiene Ø 50 mm
Cross connector for 4-channel keder rail Ø 50 mm

	Nr. no.	VE PU	Material material
	50462	1 St.	Aluminium · aluminium

Adapter für 4-Kanal Kederschiene Ø 50 mm
Adapter for 4-channel keder rail Ø 50 mm

	Nr. no.	VE PU	Ausführung, Material description, material
	50242	1 St.	für einen sauberen Abschluss zur T-Verbindung mit Flexverbinder Art.-Nr. 50005, Alu eloxiert · for a clean finish as a T-connection with Flex connector Art.-No. 50005, aluminium anodised

Klemmhalterung für Messestände Clamping bracket for exhibition stands

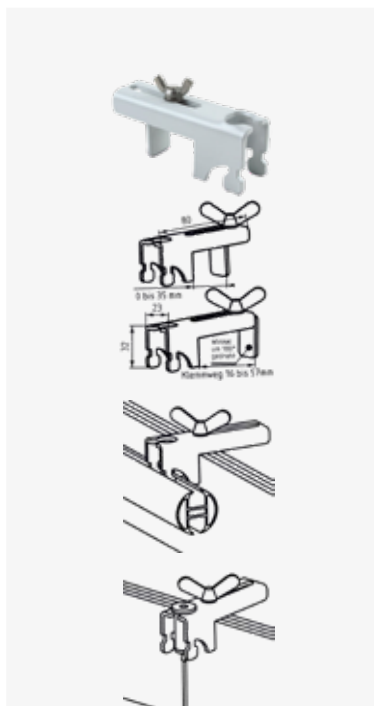

Nr. no.	VE PU	Spannweg way of stretch	Ausführung, Material description, material
50120	1 / 10 St.	16 - 57 mm	zum Abhängen von Kederschiene in der Nut oder mit einem Seilhalter, Stahl pulverbeschichtet for suspension of keder rails in the groove or with a cable holder, steel powder-coated

2-Kederhalter, Edelstahl, für Kederschiene Ø 30 mm / 15 x 30 mm 2-Keder holder, inox, fits for keder rails Ø 30 mm / 15 x 30 mm

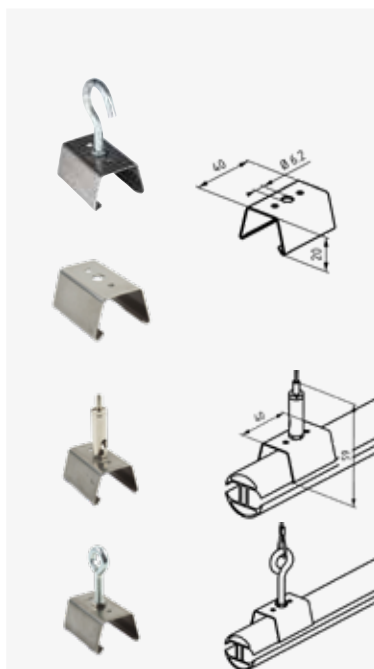

Nr. no.	VE PU	Ausführung, Material description, material
50148	1 / 10 St.	mit Hakenschraube fertig montiert, Edelstahl/Stahl verzinkt fully assembled with a hook screw, stainless steel/steel zinc plated
50150	1 St.	ermöglicht die horizontale Anordnung der Kederkanäle zum Einziehen von zwei Stoffen, ersetzt somit die 3-Kanalschiene, Edelstahl - enables horizontal assembly of keder channels for joining 2 fabrics, replace a 3-channel keder profile, stainless steel
50151	1 St.	mit Seilspanner fertig montiert, Edelstahl/Messing vernickelt fully assembled with a cable tensioner, stainless steel/brass nickel-plated
50152	1 St.	mit Ösenschaube fertig montiert, Edelstahl/Stahl verzinkt fully assembled with an eyebolt, stainless steel/steel zinc plated

Schienenverbinder, Alu / Messing vernickelt Rail connector, aluminium / brass nickel plated

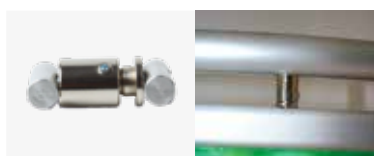

Nr. no.	VE PU	Ausführung, Material description, material
50275	1 St.	Schienenabstand 23 mm, gerade, Alu/Messing vernickelt rail gap 23 mm, straight, aluminium/brass nickel-plated

Schienenverbinder, Alu/Messing vernickelt
 Rail connector, aluminium/brass nickel plated



Nr. no.	VE PU	Ausführung, Material description, material
50277	1 St.	Alu/Messing vernickelt, Spannweg (Schienenabstand): L-max = 63 mm, L-min = 43 mm, spannbar tension distance (rail gap): L-max = 63 mm, L-min = 43 mm

Rollgleiter zur Montage von Platten in Alukederschienen
 Roller slider for installing panels to aluminium keder rails

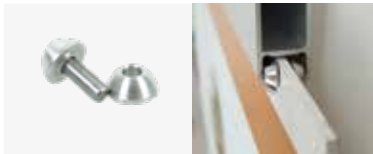

Nr. no.	VE PU	Ausführung, Material description, material
50388	1 St.	passend bis Plattenstärke von 4 mm, Aluminium fits up to panel thickness of 4 mm, aluminium

Einschlagclip – super schnelle Montage! Einfach mit Hammer zuclipen!
 Impact clip – super quick assembly! Simply clip with a hammer!



Nr. no.	VE PU	Ø	Länge length	Farbe colour	Ausführung, Material description, material
11724	100 St.	7 - 10 mm	62 mm	weiß white	mit Alugleiter für Alukederschienen mit Kedernut, Kunststoff/Aluminium, 40 kg Festigkeit pro Clip with aluminium roller slider for aluminium keder rails, plastic/aluminium, 40 kg strength per clip

Standfuss für 4-Kanal Kederschienen
 Base for 4-channel keder rails



Nr. no.	VE PU	Ø	Gewicht weight	Farbe colour	Material · material
50123	1 St.	300 mm	3 kg	silber silver	Stahl pulverbeschichtet steel powder-coated

Standfuss für 4-Kanal Kederschienen
 Base for 4-channel keder rails



Nr. no.	VE PU	Breite width	Länge length	Gewicht weight	Farbe colour	Material · material
50340	1 St.	60 mm	370 mm	2.8 kg	silber silver	Stahl pulverbeschichtet steel powder-coated



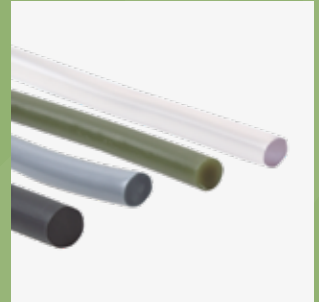

SEILE
CABLES

Kunststoffplanenseil, PVC 70 shore
 Plastic tarpaulin cable, PVC 70 shore

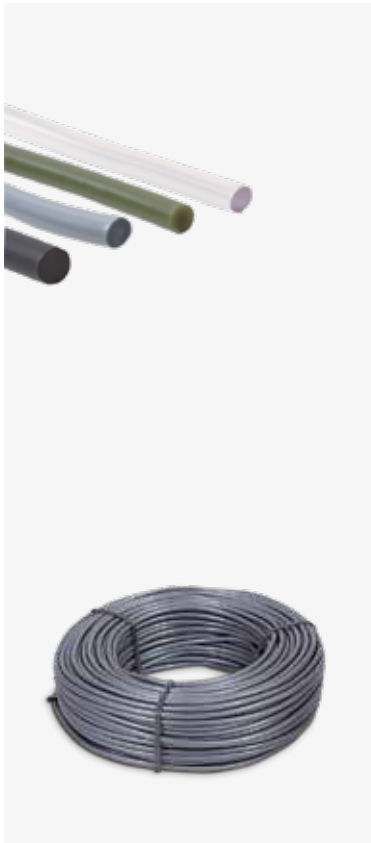

NR. no.	VE PU	Ø	Farbe colour	Ausführung · description
10113	100 lfm	6 mm	transparent	
10114	250 lfm		transparent	
10118	100 lfm		silber · silver	
10117	250 lfm		silber · silver	
10121	100 lfm	8 mm	transparent	
10122	250 lfm		transparent	
10119	100 lfm		silber · silver	
10120	250 lfm		silber · silver	
10611	100 lfm		oliv · olive	
12327	200 lfm		schwarz · black	80 shore für Kedereinlage 80 shore for keder inlay
10123	100 lfm	9 mm	transparent	
10125	100 lfm		silber · silver	
10127	100 lfm	10 mm	transparent	
10129	250 lfm		schwarz · black	80 shore für Kedereinlage 80 shore for keder inlay
11968	50 lfm		schwarz · black	80 shore für Kedereinlage 80 shore for keder inlay
10130	100 lfm		silber · silver	
12324	100 lfm		schwarz · black	
10132	100 lfm	12 mm	transparent	

Kunststoffplanenseil mit Nylon-Einlage
 Plastic tarpaulin cable with nylon core

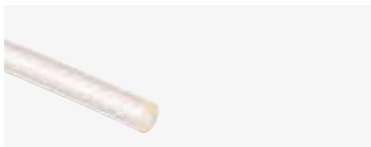

NR. no.	VE PU	Ø	
10140	100 lfm	8 mm	
10141	250 lfm		

Kunststoffplanenseil mit Stahleinlage (Zollseil)
 Plastic tarpaulin cable with steel core (customs-approved "TIR" cable)

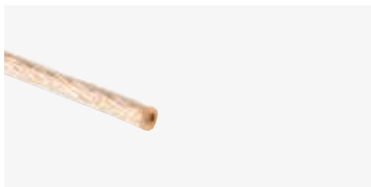

NR. no.	VE PU	Ø	
10610	100 lfm	6 mm	
10134	250 lfm		
10136	100 lfm	8 mm	

Zollseil, fertig montiert mit Zollendstücken

Customs-approved ("TIR") cable, complete with cable ends



NR. no.	VE PU	Ø	Länge length	
11418	1 St.	6 mm	20.2 m	
10403	1 St.		20.7 m	
10404	1 St.		22.0 m	
10405	1 St.		23.0 m	
10268	1 St.		34.0 m	
10409	1 St.		35.0 m	
11414	1 St.	8 mm	36.0 m	
11419	1 St.		20.2 m	
10884	1 St.		22.2 m	
11420	1 St.		33.2 m	
11421	1 St.		34.2 m	
11428	1 St.		35.2 m	

Expanderseil, PE ummantelt (UV-Beständig) mit Multieinlage

Elastic cable, with PE coated (UV-proof) with multiples cores

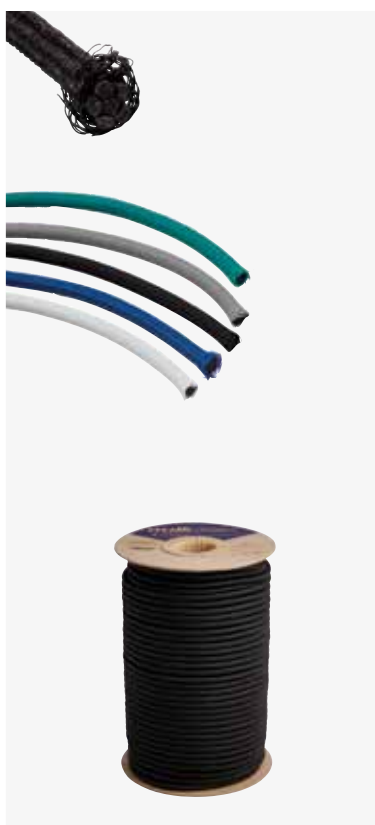

NR. no.	VE PU	Ø	Farbe colour	Ausführung, Material description, material
11651	100 lfm	3 mm	weiß · white	PP ummantelt · PP sheathing
11650	100 lfm		schwarz · black	PP ummantelt · PP sheathing
11122	100 lfm	4 mm	weiß · white	
11003	100 lfm		schwarz · black	
10169	100 lfm	6 mm	weiß · white	
10170	100 lfm		schwarz · black	
10171	100 lfm		blau · blue	
10973	100 lfm		grau · grey	
10172	100 lfm	8 mm	weiß · white	
10173	100 lfm		schwarz · black	
10174	100 lfm		grau · grey	
10175	100 lfm		grün · green	
10176	100 lfm		blau · blue	
10715	100 lfm	10 mm	rot · red	
10177	100 lfm		weiß · white	
10178	100 lfm		schwarz · black	
12051	100 lfm		grau · grey	
10925	50 lfm	12 mm	weiß · white	mit schwarzem Faden, PES ummantelt with black thread, PES sheathing

Expanderseil, PE ummantelt (UV-Beständig) mit Monoeinlage

Elastic cable, with PE coated (UV-proof) with single-core

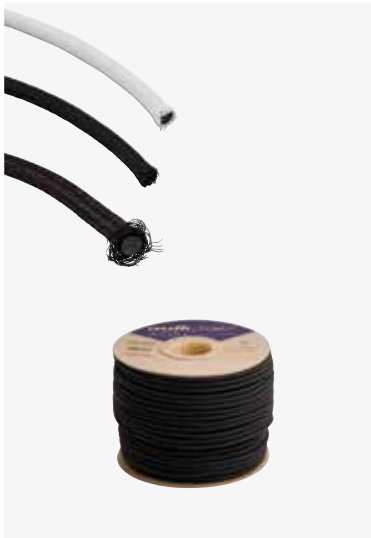

NR. no.	VE PU	Ø	Farbe · colour	
11978	100 lfm	6 mm	schwarz · black	
10670	100 lfm	8 mm	weiß · white	
10676	100 lfm		schwarz · black	
10673	100 lfm		grau · grey	
10541	100 lfm	10 mm	weiß · white	
10853	100 lfm		schwarz · black	
12005	100 lfm		grau · grey	

Expanderseil, PP ummantelt (UV-Beständig) mit Monoeinlage, weiche Ausführung

Elastic cable, with PP coated (UV-proof) with single-core, soft model



NR. no.	VE PU	Ø	Farbe · colour	
11895	100 lfm	6 mm	weiß · white	
11896	100 lfm		schwarz · black	
11897	100 lfm	8 mm	weiß · white	
11898	100 lfm		schwarz · black	
11899	100 lfm		oliv-grün · olive green	
11900	100 lfm	10 mm	weiß · white	
11901	100 lfm		schwarz · black	

Expanderseil, PES ummantelt (UV-Beständig) mit Monoeinlage, weiche Ausführung

Elastic cable, with PES coated (UV-proof) with single-core, soft model



NR. no.	VE PU	Ø	Farbe · colour	Ausführung · description
11137	100 lfm	6 mm	weiß · white	mit schwarzem Faden with black thread
11138	100 lfm	8 mm	weiß · white	mit schwarzem Faden with black thread
11484	100 lfm	10 mm	weiß · white	mit schwarzem Faden with black thread

Expanderseil mit 2 Spiralhaken (UV-Beständig)

Elastic cable with 2 spiral hooks (UV-proof)



NR. no.	VE PU	Ø	Länge length	Farbe · colour	
11131	10 St.	8 mm	400 mm	schwarz · black	
11132	10 St.		800 mm	schwarz · black	
11133	10 St.		1000 mm	schwarz · black	
11134	10 St.	10 mm	1000 mm	schwarz · black	
11135	10 St.		1500 mm	schwarz · black	

Expanderschlinge mit Knebel (UV-Beständig)

Elastic loop with toggle (UV-proof)



NR. no.	VE PU	Ø	Länge length	Farbe · colour	
11974	50 St.	6 mm	180 mm	weiß · white	
11369	50 St.		200 mm	blau · blue	
11973	50 St.		200 mm	grau · grey	
11975	50 St.		400 mm	grün · green	
11976	50 St.		400 mm	blau · blue	

Expanderschlinge mit Kunststoffhaken (UV-Beständig)

Elastic loop with plastic hooks (UV-proof)



NR. no.	VE PU	Ø	Länge length	Farbe · colour	
11058	25 St.	4 mm	200 mm	weiß · white	
11059	25 St.		200 mm	schwarz · black	
11448	25 St.		250 mm	weiß · white	
11447	25 St.		250 mm	schwarz · black	
11060	25 St.		350 mm	weiß · white	
11061	25 St.		350 mm	schwarz · black	
11483	25 St.		500 mm	weiß · white	



Expanderschlinge mit Spiralhaken (UV-Beständig)

Elastic loop with spiral hooks (UV-proof)



NR. no.	VE PU	Ø	Länge length	Farbe · colour	
11125	25 St.	6 mm	130 mm	schwarz · black	
10985	25 St.		180 mm	weiß · white	
10986	25 St.		180 mm	schwarz · black	
12330	25 St.		200 mm	schwarz · black	
10987	25 St.		250 mm	weiß · white	
10988	25 St.		250 mm	schwarz · black	
11123	25 St.		450 mm	weiß · white	
11124	25 St.		600 mm	weiß · white	

Expanderschlinge mit Kunststoffkugel (UV-Beständig)

Elastic loop with plastic-ball (UV-proof)



NR. no.	VE PU	Ø	Länge length	Farbe · colour	
11126	25 St.	6 mm	180 mm	weiß · white	
11127	25 St.		180 mm	schwarz · black	
11128	25 St.		250 mm	weiß · white	
11129	25 St.		250 mm	schwarz · black	

Für Ösen bis Ø 20 mm.
For eyelets up to Ø 20 mm.

Expanderspanngurt

Expander belt

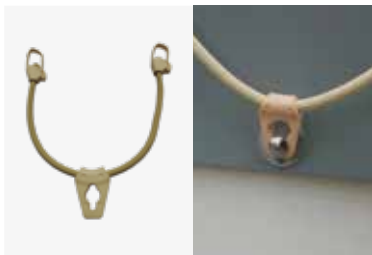

NR. no.	VE PU	Ø	Länge length	Farbe · colour	
12268	1 St. / 10 St.	9 mm	600 mm	beige · beige	

Zum Absichern von Abdeckungen (z. B. Pools, Teichen, etc.).
For securing covers (e.g. pools, ponds, etc.).

Sicherheitspin

Safety pin



NR. no.	VE PU	Länge length	Material · material
12269	1 St. / 10 St. / 250 St.	60 mm	Alu/NIROSTA · aluminium/stainless steel

Tauwerkseil aus Polyamid (PA/UV stabilisiert) 8-fach geflochten rigging rope of polyamide (PA/UV stabilised) 8 fold braided



NR. no.	VE PU	Ø	Reißfestigkeit tear strength	Farbe · colour	
11736	500 lfm	2 mm	80 daN	weiß · white	
11737	500 lfm	3 mm	120 daN	weiß · white	
10864	200 lfm	4 mm	220 daN	weiß · white	
11230	200 lfm	5 mm	350 daN	weiß · white	
10865	100 lfm	6 mm	480 daN	weiß · white	
10866	100 lfm	8 mm	790 daN	weiß · white	
11738	100 lfm	10 mm	1000 daN	weiß · white	
11739	100 lfm	12 mm	1290 daN	weiß · white	

Tauwerkseil aus Polypropylen (PP) 3-schäftig rigging rope of polypropylene (PP) 3 strands



NR. no.	VE PU	Ø	Farbe · colour	
10581	220 lfm	6 mm	weiß · white	
10582	220 lfm	8 mm	weiß · white	
11283	220 lfm		schwarz · black	

Kordelstopper, Kunststoff schwarz Cord stopper, plastic black



NR. no.	VE PU	Farbe · colour	Ausführung · description
11781	1 St.	schwarz · black	einfach, für Seile von Ø 5 - 7 mm simple, for ropes from Ø 5 - 7 mm
11783	1 St.	schwarz · black	doppelt, mit 2-fachem Seilzug für Seile von Ø 3 - 5 mm double, for 2 cables from Ø 3 - 5 mm



Edelstahlseil Inox cable

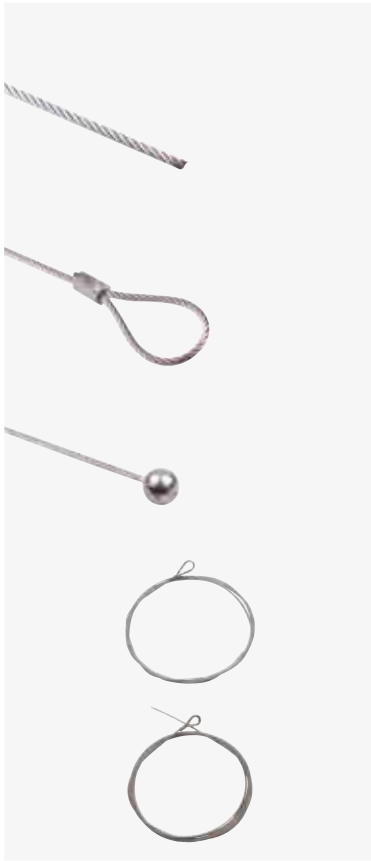

NR. no.	VE PU	Ø	Länge · length	Ausführung, Material description, material
50022	1/10 St.	1.5 mm	500 mm Fixlänge	Edelstahl · stainless steel
50023	1/10 St.		1500 mm Fixlänge	Edelstahl · stainless steel
50024	1/10 St.		3000 mm Fixlänge	Edelstahl · stainless steel
50025	1/10 St.	1.5 mm	500 mm Fixlänge	mit 3 cm Schlaufe, Edelstahl with 3 cm loop, stainless steel
50026	1/10 St.		1500 mm Fixlänge	mit 3 cm Schlaufe, Edelstahl with 3 cm loop, stainless steel
50027	1/10 St.		3000 mm Fixlänge	mit 3 cm Schlaufe, Edelstahl with 3 cm loop, stainless steel
50702	1/10 St.		5000 mm Fixlänge	mit 3 cm Schlaufe, Edelstahl with 3 cm loop, stainless steel
50551	1/10 St.	3 mm	1500 mm Fixlänge	mit 3 cm Schlaufe, Edelstahl with 3 cm loop, stainless steel
50552	1/10 St.		3000 mm Fixlänge	mit 3 cm Schlaufe, Edelstahl with 3 cm loop, stainless steel
50674	1/10 St.		5000 mm Fixlänge	mit 3 cm Schlaufe, Edelstahl with 3 cm loop, stainless steel
50282	1/10 St.	1.5 mm	500 mm Fixlänge	mit 8 mm Kugel, Edelstahl with 8 mm ball, stainless steel
50283	1/10 St.		1500 mm Fixlänge	mit 8 mm Kugel, Edelstahl with 8 mm ball, stainless steel
50284	1/10 St.		3000 mm Fixlänge	mit 8 mm Kugel, Edelstahl with 8 mm ball, stainless steel
50681	1/10 St.	1.5 mm	3000 mm Fixlänge	Edelstahl, einseitige Schlaufe, mit Kausche verpresst · stainless steel, loop on one side. pressed with thimble
50682	1/10 St.	3.0 mm	3000 mm Fixlänge	Edelstahl, einseitige Schlaufe, mit Kausche verpresst · stainless steel, loop on one side. pressed with thimble

Edelstahlseil Inox cable on reel



Nr. no.	VE PU	Ø	Material · material
50021	100 lfm	1.5 mm	Edelstahl · stainless steel
50490	100 lfm	3 mm	Edelstahl · stainless steel

Stahlseil (verzinkt) auf Rolle Steel cable (zinc plated) on reel



NR. no.	VE PU	Ø	Material · material
50491	100 lfm	3 mm	Stahl verzinkt · steel zinc plated

Nylonseil Nylon cable



Nr. no.	VE PU	Ø	Farbe colour	
50072	100 lfm	1.5 mm	transparent	

Absperr-Kette rot weiss Spring chain red white

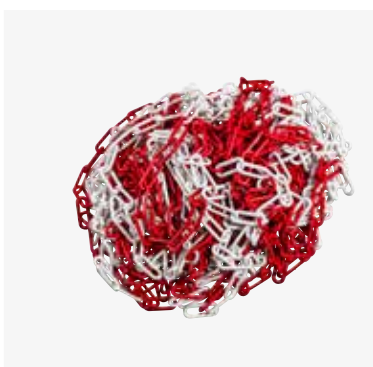

NR. no.	VE PU	*	Ausführung, Material description, material
12374	30 lfm	6 mm	Teilung 40 mm, zum Absperrn von zum Beispiel einer Baustelle oder eines Messestands, PE To block off a construction site or a trade fair stand, for example, PE

Seilklemme Cable clamp



NR. no.	VE PU	Ausführung, Material description, material
50012	100 St.	zum Verpressen von Stahlseile Ø 1.5 mm, Aluminium for pressing steel ropes Ø 1.5 mm, aluminium
50523	100 St.	zum Verpressen von Stahlseile Ø 3.0 mm, Aluminium for pressing steel ropes Ø 3.0 mm, aluminium

Seilklemme für 3 mm Stahlseile Cable clamp for 3 mm steel ropes



Nr. no.	VE PU	Material · material
50494	1 / 100 St.	Stahl verzinkt · steel zinc plated
50495	1 / 100 St.	Nirosta · INOX



Handzange und Schere Crimping plier and cutter

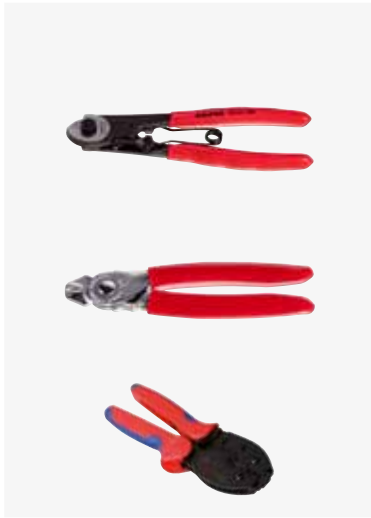

NR. no.	VE PU	Ausführung, Material description, material
50079	1 St.	Drahtseilschere zum Ablängen von Edelstahlseilen wire rope cutter for easy shortening of INOX cables
10540	1 St.	Handzange zum leichten Anpressen der NIROSTA-Seilklemmen hand crimping plier for easy pressing of INOX cable clamps
50053	1 St.	Handpresszange zum Verarbeiten von Seilklemmen für Edelstahlseile Ø 1.5 mm · hand crimping plier for easy pressing cable clamps for INOX cables Ø 1.5 mm

Kabelbinder cable strap



NR. no.	VE PU	Breite width	Länge length	Farbe · colour	Ausführung · description
50137	100 St.	2.5 mm	102 mm	transparent	
50138	100 St.	3.6 mm	205 mm	transparent	
50139	100 St.	4.8 mm	282 mm	transparent	
50140	100 St.	4.8 mm	432 mm	transparent	
50141	100 St.	8.0 mm	450 mm	transparent	
50142	100 St.	2.5 mm	102 mm	schwarz · black	UV-proof
50143	100 St.	3.6 mm	205 mm	schwarz · black	UV-proof
50144	100 St.	4.8 mm	282 mm	schwarz · black	UV-proof
50145	100 St.	4.8 mm	432 mm	schwarz · black	UV-proof
50146	100 St.	8.0 mm	450 mm	schwarz · black	UV-proof

Klemmschloss mit vernähten Gurtbändern Camlock buckle with stitched webbing



NR. no.	VE PU	Breite width	Länge length	Reißfestigkeit tear strength	Farbe · colour
11986	1 St.	18 mm	80 cm	150 daN	grau meliert · grey mottled
11987	1 St.	20 mm	40 cm	180 daN	schwarz · black
11988	1 St.	25 mm	55 cm	250 daN	blau · blue
11989	1 St.	25 mm	250 cm	250 daN	schwarz · black
11990	1 St.	25 mm	300 cm	250 daN	schwarz · black
11991	1 St.	25 mm	300 cm	250 daN	weiß · white
11992	1 St.	25 mm	400 cm	250 daN	schwarz · black
11993	1 St.	25 mm	450 cm	250 daN	weiß · white
11994	1 St.	25 mm	450 cm	250 daN	schwarz · black
11995	1 St.	25 mm	500 cm	250 daN	schwarz · black
11996	1 St.	25 mm	600 cm	250 daN	schwarz · black



KEDER & ZUBEHÖR

KEDERS &
ACCESSORIES

Zeltkeder einfahrig, zum Verschweissen

Tent keder single-tongue design, for welding



NR. no.	VE PU	Ø	F	Z	Farbe · colour	Ausführung description
10523	100 lfm	5.5 mm	25 mm	5 mm	weiß · white	
10392	100 lfm	7.5 mm	30 mm	5 mm	weiß · white	
11539	100 lfm	7.5 mm	30 mm	5 mm	silbergrau · silver grey	
10393	100 lfm	8.5 mm	30 mm	5 mm	weiß · white	
10525	100 lfm	10 mm	30 mm	5 mm	weiß · white	
10724	100 lfm	10 mm	50 mm	10 mm	weiß · white	Panama-Rollfixkeder
10928	100 lfm	13 mm	45 mm	10 mm	weiß · white	

Zeltkeder einfahrig, zum Vernähen

Tent keder single-tongue design, for sewing



NR. no.	VE PU	Ø	F	Farbe · colour	Ausführung description
10399	100 lfm	7.5 mm	20 mm	weiß · white	
11540	100 lfm	7.5 mm	20 mm	silbergrau · silver grey	
10400	100 lfm	8.5 mm	20 mm	weiß · white	
10304	100 lfm	10 mm	25 mm	weiß · white	Panama
10735	100 lfm	13 mm	25 mm	weiß · white	Panama

Zeltkeder doppelfahrig, zum Verschweissen

Tent keder double-tongue design, for welding



NR. no.	VE PU	Ø	F	Z	Farbe · colour	Ausführung description
10394	100 lfm	7.5 mm	30 mm	5 mm	weiß · white	
11174	100 lfm	7.5 mm	30 mm	5 mm	schwarz · black	
10395	100 lfm	8.5 mm	30 mm	5 mm	weiß · white	
11295	100 lfm	8.5 mm	40 mm	5 mm	weiß · white	
11175	100 lfm	8.5 mm	30 mm	5 mm	schwarz · black	
11367	100 lfm	10 mm	30 mm	5 mm	weiß · white	
12122	100 lfm	10 mm	40 mm	5 mm	schwarz · black	

Zeltkeder doppelfahrig (Panama), zum Verschweissen

Tent keder double-tongue design (Panama fabric), for welding



NR. no.	VE PU	Ø	F	Z	Farbe · colour	Ausführung description
10592	100 lfm	8.5 mm	30 mm	5 mm	weiß · white	
10396	100 lfm	11 mm	40 mm	10 mm	weiß · white	
10398	100 lfm	13 mm	40 mm	10 mm	weiß · white	

Andere Abmessungen produzieren wir gerne!
We also supply customised dimensions!



Zeltkeder doppelfahrig (Panama / 2200 DTEX), zum Verschweissen
Tent keder double-tongue design (Panama fabric / 2200 DTEX), for welding



NR. no.	VE PU	Ø	F	Z	Farbe · colour	
10417	100 lfm	7.5 mm	30 mm	5 mm	weiß · white	
10946	100 lfm	8.5 mm	30 mm	5 mm	weiß · white	
11171	100 lfm	11 mm	40 mm	10 mm	weiß · white	
10947	100 lfm	13 mm	40 mm	10 mm	weiß · white	

Zeltkeder doppelfahrig (schwer entflammbar), zum Verschweissen
Tent keder double-tongue design (flame-retardant), for welding



NR. no.	VE PU	Ø	F	Z	Farbe · colour	Ausführung description
11543	100 lfm	8.5 mm	30 mm	5 mm	weiß · white	Panama
11176	100 lfm	11 mm	40 mm	10 mm	weiß · white	Panama
11177	100 lfm	13 mm	40 mm	10 mm	weiß · white	Panama

Zeltkeder doppelfahrig und opaque, zum Verschweissen
Tent keder double-tongue design and opaque, for welding



NR. no.	VE PU	Ø	F	Z	Farbe · colour	
11537	100 lfm	8.5 mm	30 mm	5 mm	weiß · white	
11172	100 lfm	11 mm	40 mm	10 mm	weiß · white	
11173	100 lfm	13 mm	40 mm	10 mm	weiß · white	

Reparaturzeltkeder (Fahne offen), zum Verschweissen
Repair-tent keder (flag open), for welding



NR. no.	VE PU	Ø	F	Z	Farbe · colour	Ausführung description
10419	100 lfm	8.5 mm	50 mm	20 mm	weiß · white	Panama
11541	100 lfm	11 mm	70 mm	50 mm	weiß · white	Panama
11542	50 lfm	13 mm	70 mm	50 mm	weiß · white	Panama

Zeltkeder aus PVC einfahrig zum Verschweissen
PVC tent keder single-tongue design for welding



NR. no.	VE PU	Ø	F	Farbe · colour	
10924	100 lfm	5.5 mm	15 mm	transparent	
11469	100 lfm	7.5 mm	15 mm	transparent	
10725	100 lfm	8.5 mm	15 mm	transparent	

Andere Abmessungen produzieren wir gerne!
 We also supply customised dimensions!



Flachkeder zum Bespannen von Bilderrahmen Flat keder for tensioning picture frames

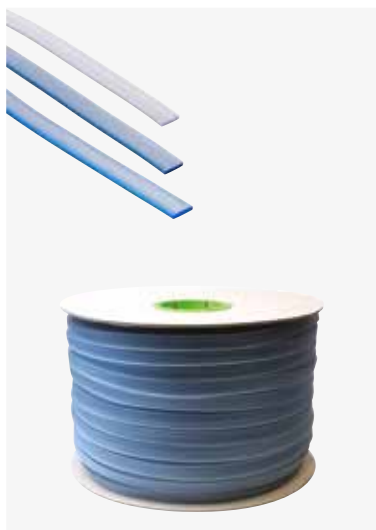

NR. no.	VE PU	Breite width	Höhe height	Ausführung, Material description, material
50396	200 lfm	11.6 mm	2.7 mm	63 shore, mit Rillen perforiert, PVC 63 shore, perforated with grooves, PVC
50256	200 lfm	12 mm	3 mm	70 shore, PVC · 70 shore, PVC
50304	200 lfm	12 mm	3 mm	70 shore, mit Rillen perforiert, PVC 70 shore, perforated with grooves, PVC
50175	200 lfm	14 mm	3 mm	70 shore, PVC · 70 shore, PVC
50300	100 lfm	14 mm	3 mm	Silikon · silicone
50394	200 lfm	14 mm	3 mm	80 shore, harte Ausführung, PVC 80 shore, heavy duty design, PVC
50632	200 lfm	14 mm	3 mm	67 shore, recyclbar mit silikonähnlichen Eigenschaften, PP · 67 shore, recyclable with silicone-like properties, PP
50636	50 lfm	14 mm	3 mm	70 shore, selbstklebend, PVC 70 shore, self-adhesive, PVC
50633	200 lfm	14 mm	3 mm	65 shore, flexibel, PVC · 65 shore, flexible PVC

Keder-Ziehband 100% PES Keder-drawstring 100% PES



NR. no.	VE PU	Breite width	Farbe colour	Ausführung · description
50575	200 lfm	5 mm	weiß white	stabiles, transparentes Band, es erleichtert das Herausziehen des Prints aus dem Rahmen stable, transparent belt, facilitating the removal of prints from the frame

STICK3 Kunststoff-Eindrückprofil STICK3 plastic crimping profile



NR. no.	VE PU	Breite width	Farbe colour	Ausführung · description
50457	1 / 20 St.	2 m	weiß white	für kederloses Bespannen von Bilderrahmenprofilen for tensioning picture frames without a keder
50460	1 lfm	auf Ihr Bildmaß zugeschnitten		für kederloses Bespannen von Bilderrahmenprofilen, inkl. Gehrungsschnitt, fertig konfektioniert for tensioning picture frames without a keder, incl. mitre cut, cut to size

Rakel Squeegee



NR. no.	VE PU	Ausführung · description	Videoanleitung instruction video
50458	1 St.	Rakel für stick3-Eindrückprofil Squeegee for stick3 crimping profile	

Pilz-Flachkeder
Mushroom-type flat keder

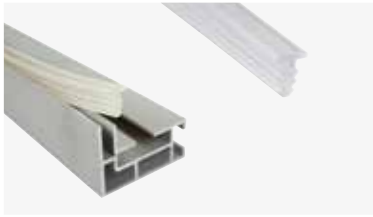

NR. no.	VE PU	Ausführung, Material description, material
50486	200 lfm	für kederloses Bespannen von Bilderrahmenprofilen, PVC for tensioning picture frame profiles without a keder, PVC

Bleiband
Lead cord



NR. no.	VE PU	Ø	Gewicht weight	Farbe colour	Ausführung · description
50637	25 lfm	5 mm	100 g/lfm	weiß white	hergestellt nach neuen EU-Richtlinien, Polyester ummantelt manufactured according to new EU directives, Polyester sheathed
50638	25 lfm	6.5 mm	150 g/lfm	weiß white	hergestellt nach neuen EU-Richtlinien, Polyester ummantelt manufactured according to new EU directives, Polyester sheathed
50639	12.5 lfm	7 mm	200 g/lfm	weiß white	hergestellt nach neuen EU-Richtlinien, Polyester ummantelt manufactured according to new EU directives, Polyester sheathed
50640	12.5 lfm	9 mm	400 g/lfm	weiß white	hergestellt nach neuen EU-Richtlinien, Polyester ummantelt manufactured according to new EU directives, Polyester sheathed

Kedereinlage
Keder inlay

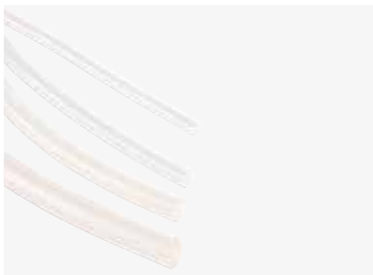

NR. no.	VE PU	Ø	Farbe · colour	Material · material
50700	200 lfm	5 mm	transparent	PVC · PVC
50697	200 lfm	6 mm	transparent	PVC · PVC
50698	200 lfm	8 mm	transparent	PVC · PVC
50699	100 lfm	10 mm	transparent	PVC · PVC

Kedereinlage – Stäbe
Keder inlay – rods



NR. no.	VE PU	Ø	Länge length	Farbe colour	Material · material	Ausführung description
50073	1 St.	8 mm	6 m		Aluminium aluminium	innen hohl hollow inside
50299	1 St.		6 m		Aluminium aluminium	Vollstab · solid rod
50631	1 St.	7 mm	6,05 m	schwarz black	PP · PP	innen hohl hollow inside

Zeltknebel Tent toggle

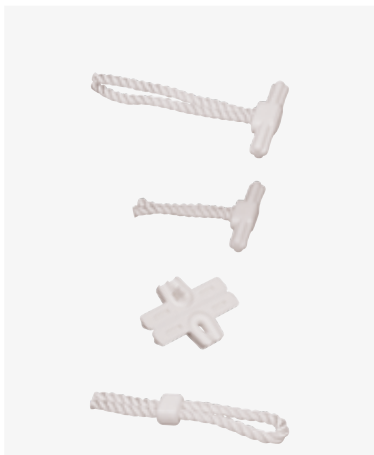
	NR. no.	VE PU	Ø	Breite width	Länge length	Farbe · colour	Ausführung, Material description, material
	10452	100 St.	6 mm	60 mm	130 mm	weiß · white	Kunststoff · plastic
	10945	100 St.		60 mm	80 mm	weiß · white	Kunststoff · plastic
	11615*	100 St.		60 mm		weiß · white	Kunststoff · plastic
	10453	100 St.		60 mm	130 mm	weiß · white	Kunststoff · plastic

* Lose, zum Montieren von Ø 5 - 6 mm Seilen
* loose, for assembling Ø 5 - 6 mm cables

Klemmgehäuse für Knebel und Schlingen (Lose) Terminal housing for toggles & loops (loose)

	NR. no.	VE PU	Breite width	Farbe colour	Material · material
	11705	100 St.	5 mm	weiß white	für Ø 5 - 6 mm Seile, Kunststoff for Ø 5 - 6 mm cables, plastic

PVC Zeltfensterfolie (schwer entflammbar), nach B1 DIN 4102 PVC tent windowfoil (flame retardant), according B1 DIN 4102

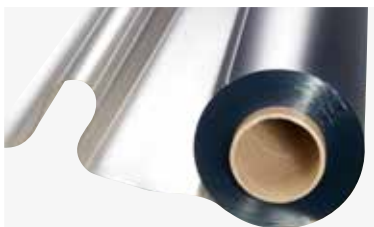
	NR. no.	VE PU	Breite width	Länge length	*	
	10245	1 St.	1.37 m	50 m	0.5 mm	
	12006	1 St.	1.83 m	30 m	0.5 mm	



PVC Zeltfensterfolie Glasklar
PVC tent windowfoil transparent



NR. no.	VE PU	Breite width	Länge length	*	Ausführung · description
10221	1 St.	1.37 m	25 m	0.4 mm	
10871	1 St.	1.37 m	50 m	0.4 mm	
10222	1 St.	1.37 m	25 m	0.5 mm	
10223	1 St.	1.37 m	40 m	0.5 mm	geringes Schrumpfverhalten low shrink
10872	1 St.	1.37 m	50 m	0.5 mm	
10681	1 St.	1.37 m	30 m	0.75 mm	
11982	1 St.	1.37 m	30 m	1 mm	
11165	1 St.	1.37 m	50 m	0.25 mm	trüb, mit Prägung opaque, with printing
11656	1 St.	1.37 m	25 m	0.5 mm	siebdruckfähig silk screen-printable
11302	1 St.	1.32 m	30 m	0.5 mm	mit Sprossen (25 x 25 cm) with glazing bars (25 x 25 cm)

Reissverschluss, mit 10 mm Spirale
Zipper, with 10 mm spiral



NR. no.	VE PU	Breite width	Farbe · colour	Ausführung · description
10623	100 lfm	40 mm	weiß · white	
10879	100 lfm	40 mm	weiß · white	YKK · YKK
10949	100 lfm	40 mm	schwarz · black	
10893	100 lfm	40 mm	schwarz · black	YKK · YKK

Schieber für Reissverschlüsse, vernickelt
Slider for zipper, nickel plated



NR. no.	VE PU	Farbe · colour	Ausführung · description
10624	1 St.		einfach · single
10880	1 St.		einfach YKK · single YKK
10881	1 St.		doppelt YKK · double YKK
12123	1 St.	schwarz · black	einfach YKK · single YKK

Endklemme für Endlosreissverschlüsse, mit 10 mm Spirale
End clamp for zipper, with 10 mm spiral



NR. no.	VE PU	Material · material
11726	100 St.	Nirosta · INOX



Reissverschluss YKK, 10 mm Spirale, teilbar mit Doppelschieber YKK zipper, 10 mm spiral, divisible, with double slider

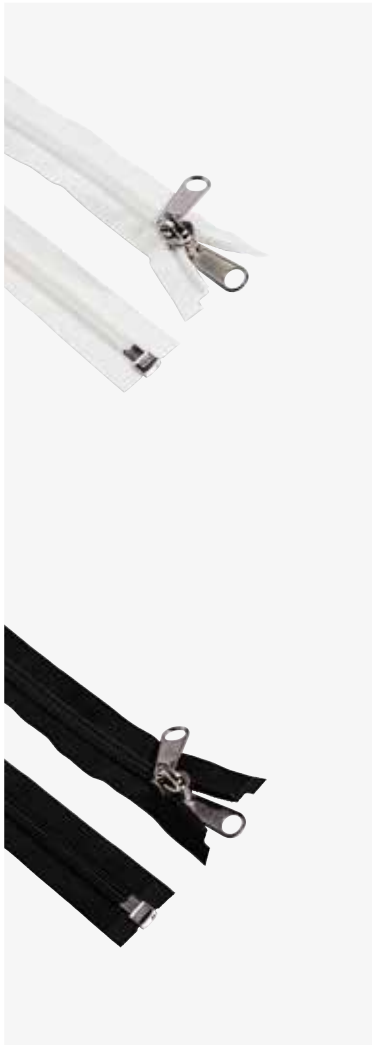

NR. no.	VE PU	Breite width	Länge length	Farbe colour
11109	1 St.	40 mm	100 cm	weiß · white
11385	1 St.	40 mm	100 cm	schwarz · black
11110	1 St.	40 mm	120 cm	weiß · white
11386	1 St.	40 mm	120 cm	schwarz · black
11111	1 St.	40 mm	150 cm	weiß · white
11387	1 St.	40 mm	150 cm	schwarz · black
11112	1 St.	40 mm	180 cm	weiß · white
11388	1 St.	40 mm	180 cm	schwarz · black
11113	1 St.	40 mm	200 cm	weiß · white
11389	1 St.	40 mm	200 cm	schwarz · black
11114	1 St.	40 mm	220 cm	weiß · white
11391	1 St.	40 mm	220 cm	schwarz · black
11115	1 St.	40 mm	240 cm	weiß · white
11392	1 St.	40 mm	240 cm	schwarz · black
11116	1 St.	40 mm	260 cm	weiß · white
11393	1 St.	40 mm	260 cm	schwarz · black
11117	1 St.	40 mm	280 cm	weiß · white
11394	1 St.	40 mm	280 cm	schwarz · black
11118	1 St.	40 mm	300 cm	weiß · white
11395	1 St.	40 mm	300 cm	schwarz · black
11119	1 St.	40 mm	400 cm	weiß · white
11396	1 St.	40 mm	400 cm	schwarz · black
11120	1 St.	40 mm	500 cm	weiß · white
11397	1 St.	40 mm	500 cm	schwarz · black
11121	1 St.	40 mm	600 cm	weiß · white
11399	1 St.	40 mm	600 cm	schwarz · black

Kugelkopfgleiter, Kunststoff Ball head slider, plastic



NR. no.	VE PU	Ø	Länge length	↔	Farbe colour	Ausführung · description
10423	100 St.	7 mm	65 mm	20 mm	weiß white	mit selbstlochenden Nieten vormontiert · preassembled with self-piercing rivets
10424	100 St.	8 mm	65 mm	20 mm	weiß white	mit selbstlochenden Nieten vormontiert · preassembled with self-piercing rivets
10425	100 St.	9 mm	65 mm	20 mm	weiß white	mit selbstlochenden Nieten vormontiert · preassembled with self-piercing rivets
10426	100 St.	12 mm	65 mm	20 mm	weiß white	mit selbstlochenden Nieten vormontiert · preassembled with self-piercing rivets
11514	100 St.	9 mm	65 mm	20 mm	weiß white	mit Schraubkappen und NIROSTA-Schrauben with screw caps and stainless steel screws
11515	100 St.	12 mm	65 mm	20 mm	weiß white	mit Schraubkappen und NIROSTA-Schrauben with screw caps and stainless steel screws

Kugelkopfgleiter „CALOTT“ Kunststoff
Ball head slider "CALOTT" plastic

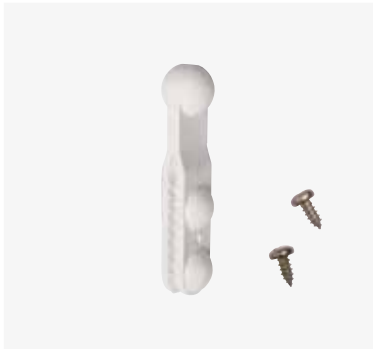

NR. no.	VE PU	Ø	Länge length	↔	Farbe colour	Ausführung · description
11511	100 St.	9 mm	65 mm	20 mm	weiß white	mit Schraubkappen und NIROSTA-Schrauben with screw caps and stainless steel screws
11512	100 St.	12 mm	65 mm	20 mm	weiß white	mit Schraubkappen und NIROSTA-Schrauben with screw caps and stainless steel screws
11513	100 St.	14 mm	65 mm	20 mm	weiß white	mit Schraubkappen und NIROSTA-Schrauben with screw caps and stainless steel screws

Kederhaken „gerade“ Kunststoff
Keder hook "straight" plastic



NR. no.	VE PU	Ø	Länge length	↔	Farbe colour	Ausführung · description
10429	100 St.	12 mm	65 mm	20 mm	weiß white	mit selbstlochenden Nieten vormontiert · preassembled with self-piercing rivets
11517	100 St.	12 mm	65 mm	20 mm	weiß white	mit Schraubkappen und NIROSTA-Schrauben with screw caps and stainless steel screws

Kederhaken „Ovalösen“ Kunststoff
Keder hook "oval eyelets" plastic



NR. no.	VE PU	Breite width	Länge length	↔	Farbe colour	Ausführung · description
11509	100 St.	16 mm	73 mm	20 mm	weiß white	mit Schraubkappen und NIROSTA-Schrauben with screw caps and stainless steel screws
11510	100 St.	16 mm	73 mm	20 mm	schwarz black	mit Schraubkappen und NIROSTA-Schrauben with screw caps and stainless steel screws

Passend für 17 x 11 mm Drehwirbel oder Montage mit Haken jeglicher Art.
Suitable for 17 x 11 mm turnable staple or assembly with all types of hooks.

Kederhaken „gekröpft“ Kunststoff
Keder hook "angled" plastic



NR. no.	VE PU	Ø	Länge length	↔	Farbe colour	Ausführung · description
10430	100 St.	12 mm	72 mm	20 mm	weiß white	mit selbstlochenden Nieten vormontiert · preassembled with self-piercing rivets
11518	100 St.	12 mm	72 mm	20 mm	weiß white	mit Schraubkappen und NIROSTA-Schrauben with screw caps and stainless steel screws

Stabgleiter für Kederprofile Kunststoff

Rod slider for keder rails plastic



NR. no.	VE PU	Ø	Länge length	↔	Farbe colour	Ausführung · description
11507	100 St.	10 mm	66 mm	20 mm	weiß white	mit Schraubkappen und NIROSTA-Schrauben with screw caps and stainless steel screws

Vorhanggleiter Kunststoff

Curtain slider plastic



NR. no.	VE PU	Ø	Breite width	Länge length	↔	Farbe colour	Ausführung description
11755	100 St.	8 mm		65 mm	20 mm	weiß white	mit Kugelkopf with ball head
11756	100 St.	12 mm		65 mm	20 mm	weiß white	mit Kugelkopf with ball head
11757	100 / 1000 St.	10 mm	38 mm	65 mm	20 mm	weiß white	mit Kugelkopf, breite Ausführung with ball head, wide model

Kederhaken gerade & verzinkt

Keder hook straight & zinc plated



NR. no.	VE PU	Ø	Breite width	Länge length	↔	
10494	100 St.	11 mm	9 mm	62 mm	20 mm	
10495	100 St.	16 mm	10 mm	64 mm	20 mm	

Kederhaken gekröpft & verzinkt

Keder hook angled & zinc plated



NR. no.	VE PU	Ø	Breite width	Länge length	↔	
10493	100 St.	11 mm	9 mm	68 mm	20 mm	
10412	100 St.	16 mm	10 mm	74 mm	20 mm	

Einhängehaken verzinkt
Suspension hook zinc plated



NR. no.	VE PU	Breite width	Länge length	↔	Ausführung · description
10595	100 St.	10 mm	66 mm	20 mm	zum Einhängen in Rollen for hooking into rollers
10496	100 St.	10 mm	66 mm	20 mm	zum Einhängen in Rundringe for hooking into round rings

Schieberhaken verzinkt
Slider hook zinc plated



NR. no.	VE PU	Breite width	Länge length	↔	Ausführung · description
10497	100 St.	10 mm	55 mm	20 mm	als Rollenalternative für Vorhangschiene Nr. 13 und Nr. 45 nail headslider for curtain rail No. 13 and No. 45

Einschlagclip – super schnelle Montage! Einfach mit Hammer zuclipsen!
Impact clip – very fast assembly! Simply clip with a hammer!

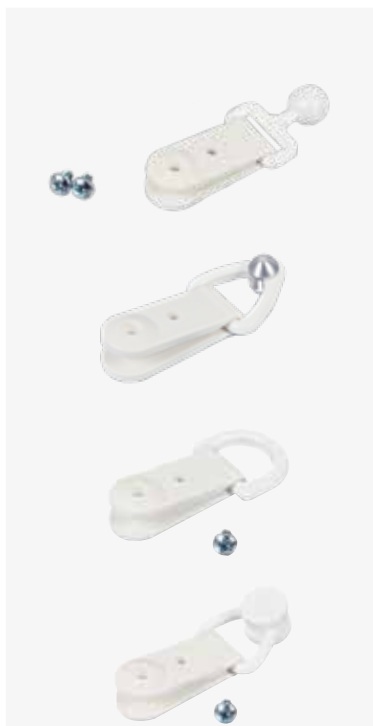

NR. no.	VE PU	Ø	Länge length	Farbe colour	Ausführung, Material description, material
11708	100 St.	11 mm	62 mm	weiß white	mit Kugelkopf, für Profil Nr. 13 und Zeltprofile with ball head, for profile No. 13 and tent profiles
11724	100 St.	7 - 10 mm	62 mm	weiß white	mit Alugleiter für Alukederschienen mit Kedernut, Kunststoff/Aluminium with aluminium roller slider for alu- minium keder rails, plastic/aluminium
11710	100 St.		62 mm	weiß white	mit Halbrundring · with half round ring
11707	100 St.		60 mm	weiß white	mit Rollenhalter für Profil Nr. 13 with roller holder for profile No. 13

40 kg Festigkeit pro Clip.
40 kg strength per clip.







BÄNDER

BELTS

Gurtband Polyester (UV-Beständig) Polyester webbing (UV-proof)

	NR. no.	VE PU	Breite width	↔	Farbe · colour	Ausführung description
	10741	250 lfm	10 mm	406 daN	weiß · white	für Fahnenhalter for flag holder
	10508	100 lfm	20 mm	640 daN	weiß · white	
	10509	100 lfm	20 mm	600 daN	schwarz · black	
	10512	100 lfm	25 mm	2200 daN	weiß · white	
	10513	100 lfm	25 mm	2200 daN	schwarz · black	
	12052	100 lfm	25 mm	1200 daN	schwarz · black	
	10802	100 lfm	25 mm	1200 daN	weiß · white	
	11332	100 lfm	25 mm	1200 daN	grau · grey	
	10657	100 lfm	25 mm	1200 daN	oliv · olive	
	10322	100 lfm	25 mm	1200 daN	oliv · olive	
	10877	100 lfm	25 mm	1200 daN	gelbgrün yellow green	
	10514	100 lfm	25 mm	2200 daN	orange · orange	Zurrgurt · lashing strap
	10305	100 lfm	25 mm	2200 daN	orange · orange	Zurrgurt · lashing strap
	12403	100 lfm	25 mm	2200 daN	silber · silver	Zurrgurt · lashing strap
	10877	100 lfm	35 mm	3000 daN	oliv · olive	Zurrgurt · lashing strap
	10514	100 lfm	35 mm	3000 daN	weiß · white	Zurrgurt · lashing strap
	10305	100 lfm	35 mm	3000 daN	rot · red	Zurrgurt · lashing strap
	12147	100 lfm	35 mm	3000 daN	orange · orange	Zurrgurt · lashing strap
	10966	100 lfm	35 mm	3000 daN	schwarz · black	Zurrgurt · lashing strap
	10655	100 lfm	35 mm	3000 daN	grün · green	Zurrgurt · lashing strap
	11819	100 lfm	35 mm	3000 daN	grau · grey	Zurrgurt · lashing strap
	10506	100 lfm	40 mm	5000 daN	weiß · white	
	10416	100 lfm	45 mm	3000 daN	schwarz · black	für Spanner · for buckles
	10515 *	250 lfm	48 mm	2500 daN	schwarz · black	Autogurt, 2. Wahl car belt, 2nd choice
	10321	100 lfm	50 mm	7500 daN	orange · orange	Zurrgurt · lashing strap
	11314	100 lfm	50 mm	6000 daN	schwarz · black	Zurrgurt · lashing strap
	10618	100 lfm	50 mm	7500 daN	blau · blue	Zurrgurt · lashing strap
	12105	100 lfm	50 mm	7500 daN	weiß · white	Zurrgurt · lashing strap
	12106	100 lfm	50 mm	7500 daN	grau · grey	Zurrgurt · lashing strap
	11847	3000 lfm	50 mm	7500 daN	orange · orange	Zurrgurt, lose im Karton lashing strap, loose in box
	11954	100 lfm	50 mm	7500 daN	rot · red	Zurrgurt · lashing strap
	12008	100 lfm	50 mm	7500 daN	orange · orange	Zurrgurt, wasser- und ölabweisend lashing strap, water and oil repellent
	12009	100 lfm	50 mm	7500 daN	orange · orange	Zurrgurt, mit reflektierenden Streifen lashing strap, with reflective stripes

* Nicht zugelassen für die Verwendung als ASG (Autosicherheitsgurt)
* Not approved for use as an car safety belt

Gurtband aus Polypropylen (PP)
Polypropylene (PP) webbing

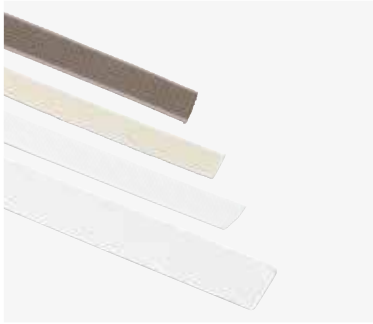

NR. no.	VE PU	Breite width	Farbe · colour	Ausführung · description
12390	100 lfm	18 mm	signalgrau signal grey	Rolladengurt · Shutter belt
10505	100 lfm	23 mm	beige · beige	Rolladengurt · Shutter belt
10507	50 lfm	20 mm	weiß · white	
10510	50 lfm	25 mm	weiß · white	
10516	100 lfm	40 mm	weiß · white	
10878	100 lfm	75 mm	weiß · white	Spleitex Nagelband · Spleitex nail trim

Gummiband
Elastic band



NR. no.	VE PU	Breite width	Farbe · colour	
12072	50 lfm	18 mm	schwarz · black	
11914	50 lfm	25 mm	weiß · white	
11493	50 lfm		schwarz · black	
11494	50 lfm	50 mm	weiß · white	
11495	50 lfm		schwarz · black	

Waschmaschinengeeignet bis 60 °C.
Machine washable up to 60 °.

Einfassband Polyester
Polyester surround band



NR. no.	VE PU	Breite width	Farbe · colour	
12014	100 lfm	20 mm	weiß · white	
12015	100 lfm		schwarz · black	
12016	100 lfm	30 mm	weiß · white	
12017	100 lfm		schwarz · black	
12018	100 lfm	50 mm	weiß · white	
12019	100 lfm		schwarz · black	
12020	100 lfm	70 mm	weiß · white	
12021	100 lfm		schwarz · black	
12022	100 lfm	90 mm	weiß · white	
12023	100 lfm		schwarz · black	
12024	100 lfm	120 mm	weiß · white	
12025	100 lfm		schwarz · black	
12026	100 lfm	160 mm	weiß · white	
12027	100 lfm	190 mm	weiß · white	

PVC Gurtband zum Verschweissen PVC webbing for welding



NR. no.	VE PU	Breite width	↔	Farbe · colour	
10197	100 lfm	48 mm	1300 kg	weiß · white	
10198	100 lfm		1300 kg	grau · grey	
10199	100 lfm		1300 kg	schwarz · black	
10200	100 lfm		2400 kg	weiß · white	
10201	100 lfm		2400 kg	grau · grey	
10202	100 lfm		2400 kg	schwarz · black	

Zertifiziert für Ladungssicherungsplanen.
Certified for load securing tarpaulins.

Schlaufenband, einseitig mit PVC beschichtet Loop belt, coated on one side with PVC



NR. no.	VE PU	Breite width	↔	Farbe · colour	Ausführung description
11952	100 lfm	50 mm	1000 kg	weiß · white	verschweißbar, rückseitig mit verwebten Schlaufen, ca. 110 mm lang, Reißfestigkeit der Schlaufe 175 kg weldable, with woven loops on the back, approx. 110 mm long, tensile strength of the loop 175 kg

Zollnahtschweissband PVC TIR tape PVC



NR. no.	VE PU	Breite width	Farbe · colour	
11235	250 lfm	7 mm	transparent	
11471	250 lfm		beige · beige	
11473	250 lfm		rot · red	
11474	250 lfm		gelb · yellow	
11475	250 lfm		blau · blue	
11476	250 lfm		schwarz · black	

Vandalismusschutzstreifen, PVC mit Stahldrahteinlage verzinkt Anti-vandalism strip, PVC with steel wire insert zinc plated



NR. no.	VE PU	Breite width	Farbe · colour	
11848	150 lfm	2.5 cm	transparent	

Ratschenzuggurt, mit automatischer Gurtaufrollmechanik
 Buckle lashing strap, with automatic roll-up mechanism



NR. no.	VE PU	Breite width	Länge length	↔	Ausführung · description
11641	1 St.	25 mm	1.85 m	250 daN	mit 2 S-Haken · with 2 S-hooks
11891	1 St.		3.00 m	250 daN	mit 2 S-Haken · with 2 S-hooks
11659	1 St.		1.85 m	250 daN	mit 2 Spitzhaken · with 2 pointed hooks
11642	1 St.	50 mm	3.00 m	500 daN	mit 2 S-Haken · with 2 S-hooks
11660	1 St.		3.00 m	500 daN	mit 2 Spitzhaken · with 2 pointed hooks

Ratschenzuggurt, mit Gurt und Haken
 Buckle lashing strap, with strap and hook



NR. no.	VE PU	Breite width	Länge length	↔	
10315	1 St.	25 mm	7.00 m	1000 kg	
10314	1 St.	35 mm	8.00 m	2000 kg	
10313	1 St.	50 mm	8.00 m	5000 kg	

Zurmulde verzinkt
 Recessed lashing ring zinc plated



NR. no.	VE PU	∅	Breite width	Länge length	Ausführung description
11426	1 St.	40 mm	105 mm	105 mm	2-teilig mit Unterplatte 2-piece with lower plate

Ratsche
 Buckle



NR. no.	VE PU	Breite width	Länge length	↔	Farbe · colour	Material material
10316	1 St.	25 mm	130 mm	1500 kg		verzinkt · zinc plated
10317	1 St.	35 mm	130 mm	2000 kg		verzinkt · zinc plated
10615	1 St.	50 mm	130 mm	2000 kg		verzinkt · zinc plated
10318	1 St.	50 mm	180 mm	5000 kg		verzinkt · zinc plated
10601	1 St.	25 mm	130 mm	1500 kg		Nirosta · INOX
10602	1 St.	35 mm	130 mm	1500 kg		Nirosta · INOX
12111	1 St.	50 mm	134 mm	2000 kg		Nirosta · INOX
10603	1 St.	50 mm	230 mm	4000 kg		Nirosta · INOX
12038	1 St.	25 mm	115 mm	800 kg	schwarz · black	Stahl lackiert steel lacquered
12382	1 St.	25 mm	132 mm	1500 kg	schwarz · black	Stahl KTL beschichtet KTL-coated steel

Kantenschutz aus PP PP edge protector

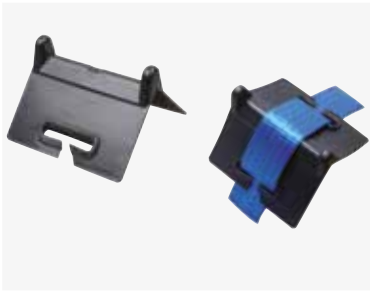

NR. no.	VE PU	Breite width	Länge length	Farbe · colour	Ausführung description
12010	1 St.	130 mm	90 mm	schwarz · black	mit Schlitz · with slot
12011	1 St.	130 mm	90 mm	schwarz · black	

Mit einer 5,5 cm Öffnung für Zurrgurte.
With a 5.5 cm opening for lashing straps.

Gurtbandabstandshalter Webbing spacer



NR. no.	VE PU	Ø	Breite width	Höhe height	Länge length	↔	Ausführung description
11607	1 / 100 St.	6 mm	28 mm	28 mm	68 mm	51 mm	für Muldenkipper etc. · for dump truck etc.
11880	100 St.	5,3 mm	25 mm	5 mm	65 mm	36 mm	

Reflektierendes Band Reflecting tape



NR. no.	VE PU	Breite width	Farbe · colour	Ausführung description
10835	50 lfm	50 mm	gelb · yellow	selbstklebend · self-adhesive
10836	50 lfm		weiß · white	selbstklebend · self-adhesive
10838	50 lfm		rot · red	selbstklebend · self-adhesive
10833	50 lfm		gelb · yellow	selbstklebend auf PVC, segmentiert self-adhesive on PVC, segmented
10834	50 lfm		weiß · white	selbstklebend auf PVC, segmentiert self-adhesive on PVC, segmented
10839	50 lfm		rot · red	selbstklebend auf PVC, segmentiert self-adhesive on PVC, segmented

Magnetband, selbstklebend mit Acrylatkleber
Magnetic tape, self-adhesive with acrylate glue



NR. no.	VE PU	Breite width	Länge length	Ausführung description
50562	1 St.	12.5 mm	30 m	Typ A, Haftkraft: 0.57 N/cm ² , magnetisierend mit Art.-Nr. 50563 · type A, adhesive force: 0.57 N/cm ² , magnetising with Art.-No. 50563
50563	1 St.		30 m	Typ B, mit Rille, Haftkraft: 0.57 N/cm ² , magnetisierend mit Art.-Nr. 50562 + 50564 · type B, with groove, adhesive force: 0.57 N/cm ² , magnetising with Art.-No 50562 + 50564
50564	1 St.	25 mm	30 m	Typ A, mit Rille, Haftkraft: 0.57 N/cm ² , magnetisierend mit Art.-Nr. 50563 · type A, with groove, adhesive force: 0.57 N/cm ² , magnetising with Art.-No 50563

Magnetplatte mit Haken
Magnetic plate with hook



NR. no.	VE PU	Ø	Farbe · colour	Ausführung description
50560	1 St.	40 mm	weiß · white	Haftkraft: 110 N · holding force: 110 N

Magnetgreifer
Magnetic gripper



NR. no.	VE PU	Ø	Ausführung description
50561	1 St.	43 mm	zum Fixieren von Folienbeschriftungen, Haftkraft: 112 N for fixing of foil labels, holding force: 112 N

Flausch & Hakenband „back to back“
Loop & hook tape “back to back”



NR. no.	VE PU	Breite width	Farbe · colour	Ausführung description
10926	25 lfm	20 mm	schwarz · black	
10927	25 lfm		weiß · white	



Klettschiene

Hook rail



NR. no.	VE PU	Breite width	Länge length	Farbe · colour	Ausführung · description
10931	1 St.	25 mm	1.20 m	schwarz · black	PVC mit Versteifung PVC with stiffener
10823	1 St.	50 mm	1.30 m	schwarz · black	PVC mit Versteifung PVC with stiffener

DUOTEC Verschlussband, selbstklebend

DUOTEC fastener strap, self-adhesive



NR. no.	VE PU	Breite width	Farbe · colour	Ausführung · description
12078	1 lfm	25 mm	schwarz · black	selbstklebend, Pilz-in-Pilz-Verschluss self-adhesive, mushroom-in-mushroom-fastener

DUOTEC Lochplatte

DUOTEC hole plate

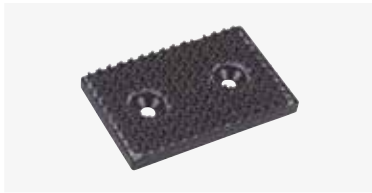

NR. no.	VE PU	Breite width	Länge length	*	Farbe colour	Ausführung · description
12077	1 St.	32 mm	50 mm	4 mm	schwarz black	zum verschrauben, Pilz-Verschluss for screwing, mushroom-type fastener

Fluschband, verschweisbar

Loop tape, for welding



NR. no.	VE PU	Breite width	Farbe · colour	
10241	25 lfm	25 mm	weiß · white	
10242	25 lfm		schwarz · black	
10248	25 lfm	50 mm	weiß · white	
10279	25 lfm		schwarz · black	
12385	25 lfm	100 mm	schwarz · black	
10935	25 lfm		grau · grey	

Hakenband, verschweisbar

Hook tape, for welding



NR. no.	VE PU	Breite width	Farbe · colour	
10238	25 lfm	25 mm	weiß · white	
10239	25 lfm		schwarz · black	
10244	25 lfm	50 mm	weiß · white	
10249	25 lfm		schwarz · black	
12384	25 lfm	100 mm	schwarz · black	
11184	25 lfm		grau · grey	

Flauschband, zum Vernähen
Loop tape, for sewing up



NR. no.	VE PU	Breite width	Farbe · colour	Ausführung · description
11790	25 lfm	20 mm	weiß · white	
11791	25 lfm		schwarz · black	
10477	25 lfm	25 mm	weiß · white	
11870	25 lfm		weiß · white	schwer entflammbar · flame-retardant
10478	25 lfm		schwarz · black	
11869	25 lfm		schwarz · black	schwer entflammbar · flame-retardant
11793	25 lfm	30 mm	weiß · white	
11792	25 lfm		schwarz · black	
11794	25 lfm	38 mm	weiß · white	
11795	25 lfm		schwarz · black	
10481	25 lfm	50 mm	weiß · white	
11871	25 lfm		weiß · white	schwer entflammbar · flame-retardant
10482	25 lfm		schwarz · black	
11872	25 lfm		schwarz · black	schwer entflammbar · flame-retardant

Hakenband, zum Vernähen
Hook tape, for sewing up



NR. no.	VE PU	Breite width	Farbe · colour	Ausführung · description
11796	25 lfm	20 mm	weiß · white	
11797	25 lfm		schwarz · black	
10479	25 lfm	25 mm	weiß · white	
10480	25 lfm		schwarz · black	
11874	25 lfm		weiß · white	schwer entflammbar · flame-retardant
11873	25 lfm		schwarz · black	schwer entflammbar · flame-retardant
11798	25 lfm	30 mm	weiß · white	
11799	25 lfm		schwarz · black	
11800	25 lfm	38 mm	weiß · white	
11801	25 lfm		schwarz · black	
10483	25 lfm	50 mm	weiß · white	
10484	25 lfm		schwarz · black	
11875	25 lfm		schwarz · black	schwer entflammbar · flame-retardant
11876	25 lfm		weiß · white	schwer entflammbar · flame-retardant

Flauschband, zum Vernähen mit 10 mm Klebestreifen
Loop tape, for sewing up with 10 mm adhesive strip

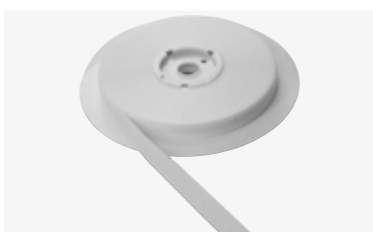

NR. no.	VE PU	Breite width	Farbe · colour	Ausführung · description
12060	25 lfm	25 mm	weiß · white	
12061	25 lfm		schwarz · black	
12064	25 lfm	50 mm	weiß · white	
12065	25 lfm		schwarz · black	



Hakenband, zum Vernähen mit 10 mm Klebestreifen

Hook tape, for sewing up with 10 mm adhesive strip



NR. no.	VE PU	Breite width	Farbe · colour	
12062	25 lfm	25 mm	weiß · white	
12063	25 lfm		schwarz · black	
12066	25 lfm	50 mm	weiß · white	
12067	25 lfm		schwarz · black	

Flauschband, selbstklebend

Loop tape, self-adhesive



NR. no.	VE PU	Breite width	Farbe · colour	
12125	50 lfm	10 mm	weiß · white	
11802	25 lfm	20 mm	weiß · white	
11803	25 lfm		schwarz · black	
10485	25 lfm	25 mm	weiß · white	
10486	25 lfm		schwarz · black	
11804	25 lfm	30 mm	weiß · white	
11805	25 lfm		schwarz · black	
11806	25 lfm	38 mm	weiß · white	
11807	25 lfm		schwarz · black	
10489	25 lfm	50 mm	weiß · white	
10490	25 lfm		schwarz · black	

Hakenband, selbstklebend

Hook tape, self-adhesive



NR. no.	VE PU	Breite width	Farbe · colour	
12126	50 lfm	10 mm	weiß · white	
11808	25 lfm	20 mm	weiß · white	
11809	25 lfm		schwarz · black	
10487	25 lfm	25 mm	weiß · white	
10488	25 lfm		schwarz · black	
11810	25 lfm	30 mm	weiß · white	
11811	25 lfm		schwarz · black	
11812	25 lfm	38 mm	weiß · white	
11813	25 lfm		schwarz · black	
10491	25 lfm	50 mm	weiß · white	
10492	25 lfm		schwarz · black	

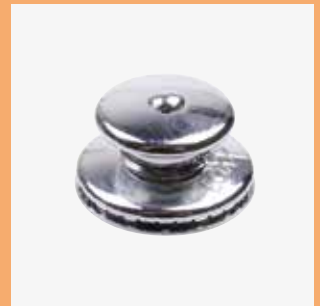
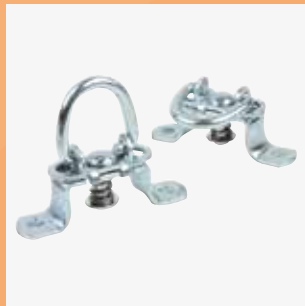

VERSCHLÜSSE

FASTENERS

Seilendverschluss

Cable end clamp



NR. no.	VE PU	Ø	Farbe · colour	Material · material
10183	100 St.	6 mm		verzinkt · zinc plated
10184	100 / 500 St.	8 mm		verzinkt · zinc plated
10895	100 St.		schwarz · black	chromatiert · chromated
11496	100 St.	9 mm		verzinkt · zinc plated
10185	100 St.	10 mm		verzinkt · zinc plated

Aus vorgeglühtem Stahl produziert, daher leicht verpressbar.
Produced from preheated steel, thus easily compressible.

Seilendverschluss 90°

Cable end clamp 90°

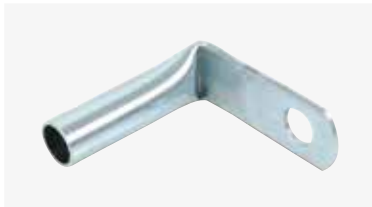

NR. no.	VE PU	Ø	Ausführung, Material description, material
11821	100 St.	8 mm	90° abgewinkelt, verzinkt 90° angled, zinc plated

Aus vorgeglühtem Stahl produziert, daher leicht verpressbar.
Produced from preheated steel, thus easily compressible.

Seilendverschluss Verbinder

Cable end clamp connector



NR. no.	VE PU	Ø	Länge length	Ausführung, Material description, material
12012	100 St.	8 mm	80 mm	Hülse zum Verbinden von 8 mm Seilen, verzinkt sleeve for connecting 8 mm ropes, zinc plated

Aus vorgeglühtem Stahl produziert, daher leicht verpressbar.
Produced from preheated steel, thus easily compressible.

Seilendverschluss mit Simplexhaken

Cable end clamp with simplex snap-hook



NR. no.	VE PU	Ø	Material · material
10188	100 St.	6 mm	verzinkt · zinc plated
10187	100 / 500 St.	8 mm	verzinkt · zinc plated
10609	100 St.	9 mm	verzinkt · zinc plated
10186	100 St.	10 mm	verzinkt · zinc plated

Simplexhaken, lose
Simplex snap-hook, loose



NR. no.	VE PU	Länge length	Farbe · colour	Material · material
10308	100 St.	40 mm		verzinkt · zinc plated
11255	100 St.			Nirosta · INOX
10894	100 St.	50 mm	schwarz · black	chromatiert · chromated
10307	100 St.	55 mm		verzinkt · zinc plated

Schlüsselring
Key ring



NR. no.	VE PU	∅	*	Ausführung, Material description, material
12033	100 St.	38 mm	2 mm	Stahl vernickelt nickel-plated steel
12110	100 St.	35 mm	3 mm	gehärtete Ausführung, Stahl vernickelt hardened version, nickel-plated steel

Würgeklemme
Crimping clamp



NR. no.	VE PU	Ausführung, Material description, material
10189	100 / 500 St.	für ∅ 6 mm Seile, verzinkt · für ∅ 6 mm Seile, zinc plated
10190	100 / 500 St.	für ∅ 8 mm Seile, verzinkt · für ∅ 8 mm Seile, zinc plated
10191	100 / 500 St.	für ∅ 10 mm Seile, verzinkt · für ∅ 10 mm Seile, zinc plated
10890	100 St.	für ∅ 12 mm Seile, verzinkt · für ∅ 12 mm Seile, zinc plated

Aus vorgeglühtem Stahl produziert, daher leicht verpressbar.
Produced from pre-annealed steel, thus easily compressible.

Handzange für Seilendverschlüsse und Würgeklemmen
Hand tool for cable end clamp and crimping clamps



NR. no.	VE PU	Ausführung · description
11606	1 St.	Zange zum leichten Anpressen von Seilendverschlüssen und Würgeklemmen · tong for easy pressing of cable end clamp and crimping clamps

Seilklemme Cable clamp



NR. no.	VE PU	Ausführung, Material description, material
10929	100 St.	für Ø 6 mm Seile, verzinkt · für Ø 6 mm Seile, zinc plated
11130	100 St.	für Ø 8 mm Seile, verzinkt · für Ø 8 mm Seile, zinc plated
11768	100 St.	für Ø 4 mm Seile, Nirosta · für Ø 4 mm Seile, INOX
10997	100 St.	für Ø 6 mm Seile, Nirosta · für Ø 6 mm Seile, INOX
10538	100 St.	für Ø 8 mm Seile, Nirosta · für Ø 8 mm Seil, INOX
10539	100 St.	für Ø 10 mm Seile, Nirosta · für Ø 10 mm Seil, INOX

Handzange für Seilklemmen Hand tool for cable clamps



NR. no.	VE PU	Ausführung · description
10540	1 St.	Handzange zum leichten Anpressen der NIROSTA-Seilklemmen hand crimping plier for easy pressing of INOX cable clamps

Zollendverschluss TIR cable end fastener



NR. no.	VE PU	Ausführung, Material description, material
10192	100 St.	für Ø 6 mm Zollseile, komplett · für Ø 6 mm TIR cable, complete
10193	100 St.	für Ø 8 mm Zollseile, komplett · für Ø 8 mm TIR cable, complete
11458	100 St.	Zollendstück Ø 6 mm, verzinkt · TIR cable end Ø 6 mm, zinc plated
11459	100 St.	Zollendstück Ø 8 mm, verzinkt · TIR cable end Ø 8 mm, zinc plated
11456	100 St.	Messingovalrohrniet für Ø 6 mm Zollendstücke brass oval rivet for Ø 6 mm TIR cable end
11457	100 St.	Messingovalrohrniet für Ø 8 mm Zollendstücke brass oval rivet for Ø 8 mm TIR cable end
11455	100 St.	Aluspitzniet 2,9 x 21 mm aluminium nail for cable ends 2,9 x 21 mm

Drehverschluss für Ovalösen 42 x 22 mm mit Nirosta-Federn Turnable staple for oval eyelets 42 x 22 mm with INOX springs



NR. no.	VE PU	Höhe height	↔	Material · material
10001	100 / 500 St.	19 mm	51 mm	Stahl verzinkt · steel zinc plated
11246	100 St.	12 mm	51 mm	Stahl verzinkt · steel zinc plated
10116	100 / 500 St.	19 mm	51 mm	Nirosta · INOX
12389	100 St.	12 mm	51 mm	Nirosta · INOX

Umklappbarer Drehverschluss für Ovalösen 42 x 22 mm mit Nirosta-Federn
Turnable staple for oval eyelets 42 x 22 mm with INOX springs



NR. no.	VE PU	Höhe height	↔	Material · material
10002	100 / 500 St.	19 mm	51 mm	Stahl verzinkt · steel zinc plated

Drehverschluss für Ovalösen 42 x 22 mm
Turnable staple for oval eyelets 42 x 22 mm



NR. no.	VE PU	↔	Farbe · colour	Material · material
10082	100 / 1000 St.	51 mm	grau · grey	Kunststoff · plastic
11383	100 / 1000 St.	53 mm	grau · grey	Kunststoff · plastic
11382	100 / 1000 St.	51 mm	schwarz · black	Kunststoff · plastic
11384	100 / 1000 St.	51 mm	weiß · white	Kunststoff · plastic

Drehverschluss „Universal“ für Ovalösen 42 x 22 mm und Rundösen Ø 40 mm
Turnable staple "universal" for oval eyelets 42 x 22 mm and round eyelets Ø 40 mm



NR. no.	VE PU	↔	Farbe · colour	Material · material
11706	100 St.	51 mm	grau · grey	Kunststoff · plastic

Drehverschluss für Ovalösen 22,5 x 13,5 mm
Turnable staple for oval eyelets 22,5 x 13,5 mm

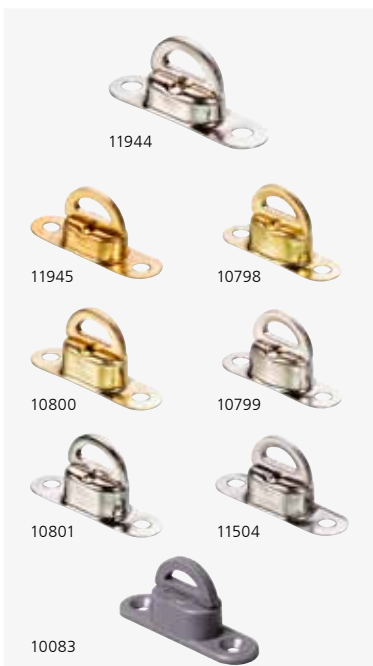

NR. no.	VE PU	Höhe height	↔	Farbe · colour	Material · material
11944	100 St.	8 mm	34 mm		Messing vernickelt brass nickel plated
11945	100 St.	8 mm	34 mm		Messing · brass
10798	100 St.	11 mm	30.5 mm		Messing · brass
10800	100 St.	11 mm	34 mm		Messing · brass
10799	100 St.	11 mm	30.5 mm		Messing vernickelt brass nickel plated
10801	100 St.	11 mm	34 mm		Messing vernickelt brass nickel plated
12075	100 St.	11 mm	30.5 mm		Nirosta · INOX
11504	100 St.	11 mm	34 mm		Nirosta · INOX
10083	100 St.	11 mm	32 mm	grau · grey	Kunststoff · plastic
10084	100 St.	11 mm	32 mm	weiß · white	Kunststoff · plastic

Drehverschluss für Ovalösen 17 x 11 mm Turnable staple for oval eyelets 17 x 11 mm

	NR. no.	VE PU	Höhe height	↔	Material · material
	10796	100 St.	11 mm	23.5 mm	Messing · brass
	11499	100 St.	8 mm	23.5 mm	Messing · brass
	10797	100 St.	11 mm	23.5 mm	Messing vernickelt · brass nickel plated
	11498	100 St.	8 mm	23.5 mm	Messing vernickelt · brass nickel plated

Schnellverschluss für Stoff-Stoff-Verbindungen Quick-action fastener for fabric/fabric attachment

	NR. no.	VE PU	Farbe · colour	Material · material
	10104	100 St.	weiß · white	Oberteil · upper part
	11375	100 St.	schwarz · black	Oberteil · upper part
	11376	100 St.	blau · blue	Oberteil · upper part
	10128	100 St.	grau · grey	Oberteil · upper part
	11378	100 St.	weinrot wine red	Oberteil · upper part
	10105	100 St.	weiß · white	Unterteil · lower part
	11379	100 St.	schwarz · black	Unterteil · lower part
	11380	100 St.	blau · blue	Unterteil · lower part
	11390	100 St.	grau · grey	Unterteil · lower part
	11381	100 St.	weinrot · wine red	Unterteil · lower part

Schlüssel für Schnellverschluss Key for quick-action fasteners

	NR. no.	VE PU	Ausführung · description
	10075	1 St.	Schlüssel zum Montieren der Schnellverschlüsse key for assembling of quick-action fasteners

Stoff-Stoff Verbindungen Fabric/Fabric Attachment



Stoff-Fest Verbindungen Fabric/Rigid Attachment

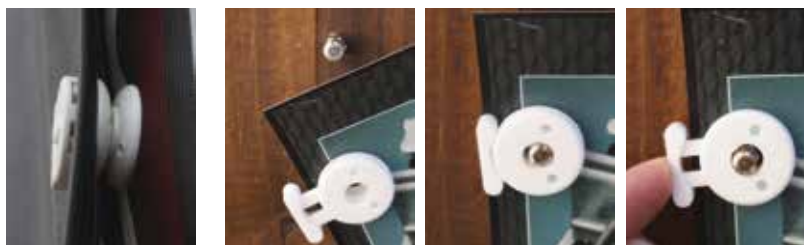

Schraube für Schnellverschlüsse, für Stoff-Fest-Verbindungen
 Screw for quick-action fasteners for fabric-rigid-attachment



NR. no.	VE PU	Ø	Länge length	Ausführung, Material description, material
10106	100 St.	4 mm	8 mm	Maschinenschraube, Messing vernickelt machine screw, brass nickel plated
10107	100 St.		12 mm	Maschinenschraube, Messing vernickelt machine screw, brass nickel plated
10108	100 St.		20 mm	Maschinenschraube, Messing vernickelt machine screw, brass nickel plated
10109	100 St.	4.3 mm	25 mm	Holzschraube, Messing vernickelt wood screw, brass nickel plated
10110	100 St.	3.5 mm	28 mm	Edelstahlschraube und Hülse, Nirosta Stainless steel screw and sleeve, INOX

Schnellverschluss, Oberteile
 Quick-action-fastener, upper parts



NR. no.	VE PU	Ø	Ausführung, Material description, material
11902	1 / 50 St.	15 mm	Messing verchromt (hochglänzend) brass chromed-plated (high-gloss finish)
11470	1 / 50 St.	15 mm	Nirosta · INOX
10662	1 / 50 St.	15 mm	Messing vernickelt · brass nickel plated
11300	1 / 50 St.	15 mm	schwarz verchromt · black chromed
11858	1 / 50 St.	15 mm	Skull antique, Messing (gunmetal) skull antique, brass (gunmetal)
11905	1 / 50 St.	10 mm	mit Bügel, Messing schwarz verchromt designed with a stirrup-type bow, brass black chrome-plated
12080	1 / 50 St.	15 mm	Messing Altmessing · brass antique brass
12081	1 / 50 St.	15 mm	Messing Altkupfer · brass antique copper

Inklusive Scheibe · Inclusive slice

Scheibe „lang“ für Oberteile Washer "long" for upper parts



NR. no.	VE PU	Ausführung, Material description, material
12085	1 / 50 St.	Messing vernickelt · brass nickel plated
12086	1 / 50 St.	Messing verchromt · brass chromed-plated
12087	1 / 50 St.	Messing schwarz verchromt · brass black chrome-plated

Zur Überbrückung von größeren Materialstärken.
For bridging of higher material thickness.

Schnellverschluss, Unterteile Quick-action-fastener, lower parts



NR. no.	VE PU	Ø	Länge length	Farbe colour	Ausführung, Material description, material
11906	1 / 50 St.				Stoff-Stoff-Verbindung, Messing verchromt (hochglänzend) fabric/fabric attachment, brass chromed-plated (high-gloss finish)
10663	1 / 50 St.				Stoff-Stoff-Verbindung, Messing vernickelt · fabric/fabric attachment, brass nickel plated
12088	1 / 50 St.			schwarz black	Stoff-Stoff-Verbindung, Messing schwarz verchromt fabric/fabric attachment, brass black chrome-plated
12096	1 / 50 St.				zum Anschrauben (2 Löcher), Messing vernickelt for screwing (2 holes), brass nickel plated
11446	1 / 50 St.				zum Anschrauben (2 Löcher) Messing verchromt (hochglänzend) for screwing (2 holes), brass chromed-plated (high-gloss finish)
11468	1 / 50 St.	4.2 mm	10 mm		Gewindeschraube. inkl. Mutter, Niosta thread screw incl. nut, INOX
12089	1 / 50 St.	4.2 mm	10 mm		Gewindeschraube inkl. Mutter mit längerem Kopf, Messing vernickelt thread screw incl. nut screw with long head, brass nickel plated
10665	1 / 50 St.	4.2 mm	12 mm		Blechschaube (selbstschneidend), Niosta · tapping screw, INOX
10664	1 / 50 St.	4.2 mm	16 mm		Blechschaube (selbstschneidend), Niosta · tapping screw, INOX
12097	1 / 50 St.	4.2 mm	12 mm	schwarz black	Blechschaube NIROSTA (selbstschneidend), Niosta schwarz verchromt · tapping screw (self-cutting), INOX black chromium-plated
11903	1 / 50 St.	4.2 mm	16 mm	schwarz black	Blechschaube NIROSTA (selbstschneidend), Niosta schwarz verchromt · tapping screw (self-cutting), INOX black chromium-plated
12082	1 / 50 St.				Dübel für Kederprofile, für 10 - 12 mm Schrauben, Kunststoff · dowel for keder rails, for 10 - 12 mm screws, plastic

Rohrschelle mit Gewindeschraube, M 6 x 8 mm inkl. Mutter

Pipe clamp with threaded bolt, m 6 x 8 mm incl. nut



NR. no.	VE PU	Ausführung, Material description, material
12083	1 / 50 St.	für Rohr Ø 22 mm, Edelstahl · for Ø 22 mm, stainless steel
12084	1 / 50 St.	für Rohr Ø 25 mm, Edelstahl · for Ø 25 mm, stainless steel

Montage-Schlüssel

Mounting key

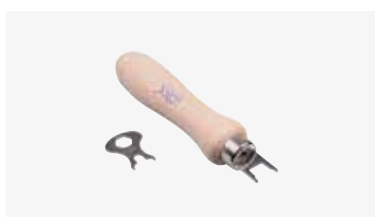

NR. no.	VE PU	Ausführung · description
11301	1 St.	zum schnellen Einsetzen der Verschlüsse for quick installation of fasteners
11907	1 St.	mit Griff, zum schnellen Einsetzen der Verschlüsse with handle, for quick installation of fasteners

Schnellverschluss, Kunststoff weiss, in Kombination mit Ø 25 mm Rundöse

Quick-fastener, plastic white, in combination with Ø 25 mm round eyelet



NR. no.	VE PU	Ausführung · description
10718	100 St.	Schnellverschluss · Quick-fastener
10875	1 St.	Schlüssel für Schnellverschluss 10718 key for quick-action-fastener 10718

 Für die „abschließbare“ Plane.
For the „lockable“ tarpaulin.

Rundknopf, Kunststoff für Ø 6 und 8 mm Seile

Round button, plastic for Ø 6 + 8 mm cables



NR. no.	VE PU	Ø	Farbe · colour	Material · material
10087	100 / 1000 St.	25 mm	schwarz · black	Kunststoff · plastic
11591	100 / 1000 St.		weiß · white	Kunststoff · plastic
11592	100 / 1000 St.		grau · grey	Kunststoff · plastic

Rundknopf groß, Kunststoff für Ø 6 und 8 mm Seile

Round button big, plastic for Ø 6 + 8 mm cables



NR. no.	VE PU	Ø	Farbe · colour	Ausführung, Material description, material
12313	100 / 1000 St.	30 mm	schwarz · black	Nietloch: 6 mm, Kunststoff Rivet hole: 6 mm plastic

Druckknopf für Stoff-Stoff-Verbindung Snap button for fabric / fabric attachment

	NR. no.	VE PU	Ausführung, Material description, material
	10499	100 St.	Kappe, Öse, Kugel, Niet, Messing vernickelt lid, eyelet, ball, rivet, brass nickel plated

Druckknopf für Stoff-Metall-Verbindung Snap button for fabric / metal attachment

	NR. no.	VE PU	Ausführung, Material description, material
	10500	100 St.	Kappe, Öse, Kugel, Schraube, Messing vernickelt lid, eyelet, ball, screw, brass nickel plated

Druckknopf für Stoff-Stoff-Verbindung (gebördelte Ausführung) Snap button for fabric / fabric attachment (flanged version)

	NR. no.	VE PU	Ausführung, Material description, material
	11920	100 St.	Gebördelte Ausführung, Kappe, Öse, Kugel, Niet, Messing vernickelt Flanged design, lid, eyelet, ball, rivet, brass nickel plated

Passendes Werkzeug, siehe Seite 167.
For matching tools, please see page 167.



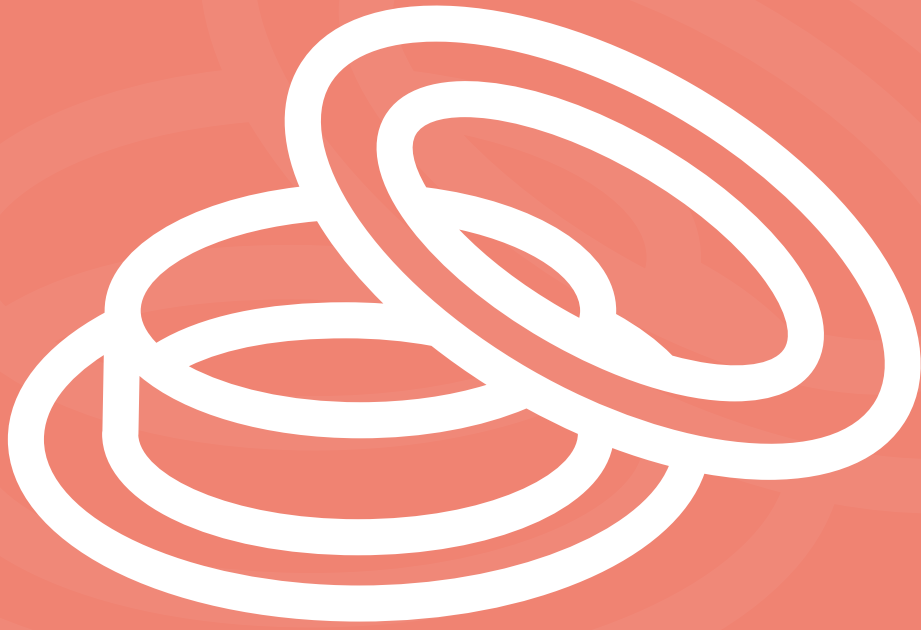

ÖSEN
EYELETS

Rundöse, verzinkt (DIN 7332)

Round eyelet, zinc plated (DIN 7332)



NR. no.	VE PU	Ø	
10323	1000 St.	10 mm	
10324	1000 St.	12 mm	
11067	500 St.	14 mm	
10325	500 St.	16 mm	
11044	500 St.	18 mm	
10326	500 St.	20 mm	
10327	200 St.	25 mm	
11353	100 St.	36 mm	
10328	500 St.	40 mm	

Rundöse, Messing (DIN 7332)

Round eyelet, brass (DIN 7332)



NR. no.	VE PU	Ø	
10630	1000 St.	8 mm	
10329	1000 St.	10 mm	
10330	1000 St.	12 mm	
10909	500 St.	14 mm	
10331	500 St.	16 mm	
10911	500 St.	18 mm	
10332	500 St.	20 mm	
10333	200 St.	25 mm	
11603	500 St.	36 mm	
10334	500 St.	40 mm	

Rundöse, Messing vernickelt (DIN 7332)

Round eyelet, brass nickel plated (DIN 7332)



NR. no.	VE PU	Ø	
10902	1000 St.	8 mm	
10563	1000 St.	10 mm	
10564	1000 St.	12 mm	
10910	500 St.	14 mm	
10565	500 St.	16 mm	
10858	500 St.	18 mm	
10566	500 St.	20 mm	
10567	200 St.	25 mm	
11604	500 St.	36 mm	
10568	500 St.	40 mm	

Passendes Werkzeug, siehe Seite 158/159.
For matching tools, please see page 158/159.

Rundöse, Nirosta (DIN 7332)
Round eyelet, INOX (DIN 7332)



NR. no.	VE PU	Ø	
11362	1000 St.	8 mm	
10335	1000 St.	10 mm	
10336	1000 St.	12 mm	
10337	500 St.	16 mm	
11160	500 St.	18 mm	
10338	500 St.	20 mm	
10339	100 St.	25 mm	
11605	500 St.	36 mm	
10340	500 St.	40 mm	

Ovalöse
Oval eyelet



NR. no.	VE PU	Breite width	Länge length	Ausführung, Material description, material
10726	100 St.	17 mm	11 mm	Messing · brass
10727	100 St.	17 mm	11 mm	Messing vernickelt · brass nickel plated
10728	100 St.	22.5 mm	13.5 mm	Messing · brass
10729	100 St.	22.5 mm	13.5 mm	Messing vernickelt · brass nickel plated
11505	100 St.	22.5 mm	13.5 mm	Nirosta · INOX
11322	100 St.	22.5 mm	13.5 mm	Messing schwarz brüniert · brass black burnished
10343	250 St.	27 mm	8 mm	eckig, verzinkt · angular, zinc plated
10347	250 St.	27 mm	8 mm	eckig, Messing · angular, brass
11238	250 St.	27 mm	7 mm	oval, verzinkt · oval, zinc plated
10344	250 St.	38 mm	8 mm	eckig, verzinkt · angular, zinc plated
10348	250 St.	38 mm	8 mm	eckig, Messing · angular, brass
10526	200 St.	40 mm	10 mm	verzinkt · zinc plated
12379	100 St.	40 mm	10 mm	Messing vernickelt · brass nickel plated
10342	1000 St.	42 mm	22 mm	verzinkt · zinc plated
10345	100 St.	42 mm	22 mm	Messing · brass
10930	100 St.	42 mm	22 mm	Messing vernickelt · brass nickel plated
10346	1000 St.	42 mm	22 mm	Nirosta · INOX
12416	100 St.	42 mm	22 mm	Messing schwarz brüniert · brass black burnished
10983	100 St.	50 mm	15 mm	Messing verzinkt · zinc plated brass
11400	100 St.	60 mm	21 mm	verzinkt · zinc plated

Passendes Werkzeug, siehe Seite 158/159.
 For matching tools, please see page 158/159.

Rundöse, Messing schwarz brüniert

Round eyelet brass, with black burnished finish



NR. no.	VE PU	Ø	
12120	1000 St.	8 mm	
11967	1000 St.	10 mm	
11232	1000 St.	12 mm	
10916	500 St.	16 mm	
11213	500 St.	20 mm	
10915	200 St.	25 mm	
11319	100 St.	40 mm	

Selbstschneidende Rundöse

Self-cutting round eyelet



NR. no.	VE PU	Ø	Ausführung, Material description, material
11333	100 St.	9 mm	Messing vernickelt, passende Handhebelpresse Art. 11646 brass nickel plated, suitable hand lever press art. 11646
11648	100 St.	12.5 mm	Ø 25 mm außen, Messing vernickelt, passende Handhebelpresse Art. 11646 Ø 25 mm outside, brass nickel plated, suitable hand lever press art. 11646
11628	100 St.	12 mm	Ø 22 mm außen, Messing vernickelt Ø 22 mm outside, brass nickel plated
11627	100 St.	11 mm	Messing verchromt, passende Ösenhandpresszange Art. 11626 · brass chrome-plated, suitable eyelet hand pressing plier art. 11626

Rundöse, mit Kragenscheibe

Round eyelet, with collar washer



NR. no.	VE PU	Ø	Material · material
11311	1000 St.	12 mm	verzinkt · zinc plated
11323	1000 St.	12 mm	Messing vernickelt · brass nickel plated
11312	1000 St.	16 mm	verzinkt · zinc plated
11653	1000 St.	16 mm	glanzverzinkt beschichtet · plated with bright zinc coated
11339	1000 St.	16 mm	Messing vernickelt · brass nickel plated
11916	1000 St.	18 mm	verzinkt · zinc plated

Für vollautomatische Ösenmaschinen, andere Größen und Materialien auf Anfrage lieferbar.
For fully automatic eyelet machines, other sizes and materials available upon request.

Zackenöse, einteilig
Prong eyelet, monobloc



NR. no.	VE PU	Ø	Material · material
11348	1000 St.	10 mm	Messing vernickelt · brass nickel plated
11942	1000 St.	12 mm	verzinkt · zinc plated
12130	1000 St.	12 mm	Messing vernickelt · brass nickel plated
11346	1000 St.	16 mm	verzinkt · zinc plated
11347	1000 St.	16 mm	Messing vernickelt · brass nickel plated
11943	1000 St.	18 mm	verzinkt · zinc plated
11349	1000 St.	40 mm	verzinkt · zinc plated

Passende Einschlagstempel, siehe Seite 159.
For matching dies, please see page 159.

Gummispannring
Rubber tensioning ring



NR. no.	VE PU	Länge length	Farbe · colour	Ausführung, Material description, material
10698	100 / 1000 St.	65 mm	crème/weiß creamy/white	Plakathalter, EPDM poster holder, EPDM
11844	100 / 1000 St.	80 mm	grau · grey	z. B. als Zeltspannringe verwendbar Can be used e.g. as tent tension rings
11845	100 / 1000 St.	120 mm	grau · grey	
10251	100 / 1000 St.	140 mm	grau · grey	

Alustegöse für Plakate
Aluminium stirrup eyelet for posters



NR. no.	VE PU	Ø	
10695	100 / 1000 St.	10 mm	

Gummispannring für Alustegöse
Rubber tensioning ring for aluminium stirrup eyelet



NR. no.	VE PU	Länge length	Farbe · colour	Ausführung, Material description, material
10698	100 / 1000 St.	65 mm	crème/weiß creamy/white	Plakathalter, EPDM poster holder, EPDM

Clipöse, Ø 12 mm Kunststoff Clip eyelet, Ø 12 mm plastic

	NR. no.	VE PU	Ø	Farbe · colour
	11529	100 / 1000 St.	12 mm	rot · red
	11530	100 / 1000 St.		blau · blue
	11531	100 / 1000 St.		gelb · yellow
	11532	100 / 1000 St.		grün · green
	11528	100 / 1000 St.		transparent
	10959	100 / 1000 St.		weiß · white
	11527	100 / 1000 St.		schwarz · black

Einfach mit Hammer zusammenschlagen!
Simply strike with a hammer!

Rundöse, synthetic Round eyelet, synthetic

	NR. no.	VE PU	Ø	Farbe · colour	Ausführung description
	11284	100 St.	12 mm	transparent	recyclbar · recyclable

Passende Handhebelpresse 11984, siehe Seite 165.
For the appropriate hand press 11984, please see page 165.

Hütchen für Edscha-Verdecke Head for Edscha-roofs

	NR. no.	VE PU	Ø	Material material	Ausführung description
	11327	100 St.	25 mm	verzinkt zinc plated	für Ø 16 - 18 mm Rundösen for Ø 16 - 18 mm round eyelets

Unterlegscheibe für Ösen, Kunststoff
Washer for eyelets, plastic



NR. no.	VE PU	Ø	
10287	1000 St.	8 mm	
10288	1000 St.	10 mm	
10289	1000 St.	12 mm	
10290	1000 St.	14 mm	
10291	1000 St.	16 mm	
11365	1000 St.	18 mm	
10292	1000 St.	20 mm	
10293	1000 St.	25 mm	
10294	1000 St.	36 mm	
10295	1000 St.	40 mm	
10296	1000 St.	42 x 22 mm	

Tecofix MIDI Klemmhalterung, Kunststoff
Tecofix MIDI clamp, plastic



NR. no.	VE PU	Breite width	Länge length	Farbe · colour	Ausführung · description
50177	250 St.	44 mm	70 mm	schwarz · black	zum Spannen von Stoffen in Verbindung mit Abspannsystemen, ohne Werkzeug leicht montierbar, Zugkraft: 100 kg for tensioning fabrics with suspension systems, easy assembly without tools, tractive power: 100 kg
50178	250 St.			weiß · white	
50183	250 St.			blau · blue	

Tecofix MINI Klemmhalterung, Kunststoff
Tecofix MINI clamp, plastic

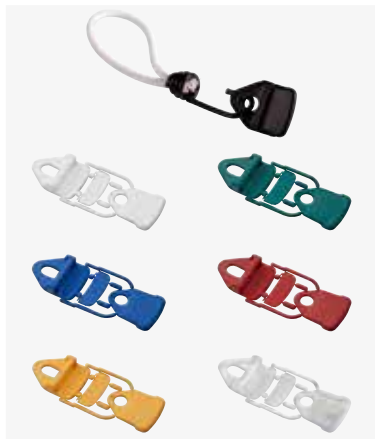

NR. no.	VE PU	Breite width	Länge length	Farbe colour	Ausführung · description
50109	250 St.	44 mm	35 mm	schwarz black	zum Spannen von Stoffen in Verbindung mit Abspannsystemen, ohne Werkzeug leicht montierbar, Zugkraft: 45 kg for tensioning fabrics with suspension systems, easy assembly without tools, tractive power: 45 kg
50132	250 St.			weiß white	
50184	250 St.			grün green	
50185	250 St.			blau blue	
50186	250 St.			rot red	
50187	250 St.			gelb yellow	
50220 *	250 St.			transparent	

* Nur für den Innenbereich geeignet.
 * Only suitable for indoor use.

Tecofix Xtra Klemmhalterung, Kunststoff
Tecofix Xtra clamp, plastic



NR. no.	VE PU	Breite width	Länge length	Farbe colour	Ausführung · description
50734	250 St.	46 mm	37 mm	schwarz black	zum Spannen von Stoffen in Verbindung mit Abspannsystemen, ohne Werkzeug leicht montierbar Zugkraft: 45 kg for tensioning fabrics with suspension systems, easy assembly without tools, tractive power: 45 kg
50739	250 St.	46 mm	37 mm	weiß white	

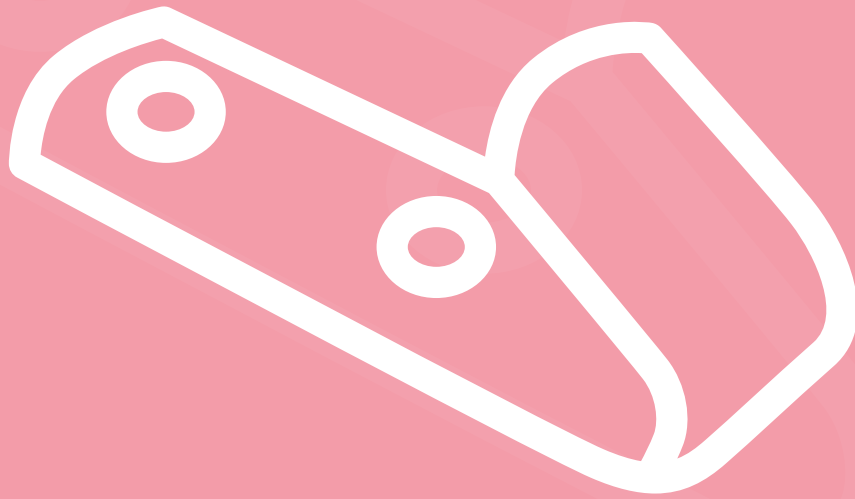

PLANENBESCHLÄGE

TARPAULIN FITTINGS

PLANENBESCHLÄGE · TARPAULIN FITTINGS

Planenhaken, Kunststoff Polyamid 6 Tarpaulin hook, plastic polyamide 6



NR. no.	VE PU	Breite width	Länge length	↔	Farbe · colour	Ausführung description
10100	100 / 1000 St.	20 mm	66 mm	20 mm	weiß · white	verstärkt reinforced
10101	100 / 1000 St.				silber · silver	verstärkt reinforced
10102	100 / 1000 St.				schwarz · black	verstärkt reinforced
12131	100 / 1000 St.				oliv · olive	verstärkt reinforced

Planenhaken, verzinkt Tarpaulin hook, zinc plated



NR. no.	VE PU	Breite width	Länge length	↔	
10180	100 St.	13 mm	70 mm	20 mm	
10181	100 St.	15 mm	70 mm		
10182	100 St.	20 mm	70 mm		

Planenhaken, Nirosta Tarpaulin hook, INOX



NR. no.	VE PU	Breite width	Länge length	↔	
10731	100 St.	13 mm	50 mm	20 mm	
10732	100 St.	15 mm	60 mm		
10733	100 St.	20 mm	60 mm		

Rundlochplanenhaken Round-hole tarpaulin hook



NR. no.	VE PU	Breite width	Länge length	↔	Farbe · colour	Material material
10977	100 St.	15 mm	60 mm	20 mm	silber · silver	Stahl verzinkt steel zinc plated
10992	100 St.	20 mm	66 mm		silber · silver	Kunststoff Polyamid 6 plastic polyamide 6
10993	100 St.	20 mm	66 mm		weiß · white	Kunststoff Polyamid 6 plastic polyamide 6

Dreilochplanenhaken, feuerverzinkt
Three-hole tarpaulin hook, fire galvanised

	NR. no.	VE PU	Breite width	Länge length	
	11139	100 St.	40 mm	50 mm	
	11240	100 St.	45 mm	50 mm	
	11908	100 St.	50 mm	40 mm	

Dreilochplanenhaken
Three-hole tarpaulin hook

	NR. no.	VE PU	Breite width	Länge length	Material · material
	11085	100 St.	40 mm	50 mm	Stahl verzinkt steel zinc plated
	11881	100 St.			NIROSTA A4 salzwasserbeständig INOX A4 salt water resistant

Dreilochplanenhaken, Kunststoff
Three-hole tarpaulin hook, plastic

	NR. no.	VE PU	Breite width	Länge length	Farbe · colour	
	11760	100 St.	50 mm	50 mm	weiß · white	
	10984	100 St.	40 mm		grau · grey	

Abspannhaken
Guy hook

	NR. no.	VE PU	Breite width	Länge length	↔	Material · material
	10265	100 / 500 St.	20 mm	65 mm	45 mm	verzinkt · zinc plated
	11412	100 St.	48 mm	40 mm	34 mm	verzinkt · zinc plated



PLANENBESCHLÄGE · TARPAULIN FITTINGS

Expanderdoppelhaken, Kunststoff

Expander double hook, plastic

NR. no.	VE PU	Farbe · colour	Ausführung, Material description, material
11590	100 St.	weiß · white	für Seile bis Ø 8 mm, Kunststoff for cables up to Ø 8 mm, plastic
11767	100 St.	schwarz · black	für Seile bis Ø 8 mm, Kunststoff for cables up to Ø 8 mm, plastic
12007	100 St.	silber · silver	für Seile bis Ø 8 mm, Kunststoff for cables up to Ø 8 mm, plastic

Zum Spannen von Stoffen in Verbindung mit Abspannsystemen, ohne Werkzeug leicht montierbar.
For tensioning fabrics with suspension systems, easy to assemble without tool.

Spiralhaken, Stahl/Kunststoff-ummantelt

Spiral hook, steel/plastic-coated

NR. no.	VE PU	Farbe · colour	Ausführung · description
10859	100 St.	schwarz · black	für Ø 6 mm Expanderseile for Ø 6 mm expander ropes
10598	100 St.	schwarz · black	für Ø 8 mm Expanderseile for Ø 8 mm expander ropes
11640	100 St.	weiß · white	für Ø 8 mm Expanderseile for Ø 8 mm expander ropes
10860	100 St.	schwarz · black	für Ø 10 mm Expanderseile for Ø 10 mm expander ropes

Doppelhaken, umgekehrt Stahl/Kunststoff-ummantelt

Double hook, inverted version steel/plastic-coated

NR. no.	VE PU	Farbe · colour	Ausführung, Material description, material
12376	100 St.	schwarz · black	für Ø 8 mm Expanderseile, umgekehrte Version for Ø 8 mm expander ropes, inverted version

Karabinerhaken, Kunststoff

Carbine hook, plastic

NR. no.	VE PU	Farbe · colour	Ausführung · description
11751	100 St.	schwarz · black	für Ø 4 mm Expanderseile for Ø 4 mm expander ropes
11500	100 St.	weiß · white	für Ø 4 mm Expanderseile for Ø 4 mm expander ropes
11047	100 St.	schwarz · black	für Ø 6 mm Expanderseile for Ø 6 mm expander ropes
10863	100 St.	schwarz · black	für Ø 8 mm Expanderseile for Ø 8 mm expander ropes

Kunststoffhaken EASY FIX, mit Sicherung für Ø 8 - 10 mm Expanderseile
 Plastic hook EASY FIX, with lock for Ø 8 - 10 mm elastic cables



NR. no.	VE PU	Breite width	Länge length	Farbe · colour	Ausführung description
11977	100 St.	40 mm	63 mm	schwarz · black	ohne Hilfsmittel montierbar mounting without tools

Knebel für Ø 8 mm Expanderseile
 Toggle for Ø 8 mm expander ropes



NR. no.	VE PU	Ø	Länge length	Farbe · colour	Ausführung description
12140	100 St.	15 mm	60 mm	weiß · white	schnelle und einfache Montage, kein Werkzeug erforderlich · quick and easy assembly, no tools required

Karabinerhaken für Gurtbänder
 Carbine hook for webbings



NR. no.	VE PU	Ø I	Farbe · colour	Material · material
10691	100 St.	20 mm		verzinkt · zinc plated
10692	100 St.	25 mm		verzinkt · zinc plated
12036	1 St.	40 mm	schwarz · black	Zink Druckguß schwarz galvanisiert Zinc die-cast black galvanized

Karabinerhaken CLIP
 Carabiner hook CLIP



NR. no.	VE PU	Ø I	Länge length	Farbe · colour	Material · material
11155	100 St.	77 mm	13 mm		vernickelt · nickel plated
11156	100 St.	82 mm	19 mm		vernickelt · nickel plated
11157	100 St.	89 mm	25 mm		vernickelt · nickel plated
12037	1 St.	75 mm	19 mm	schwarz · black	Zink Druckguß schwarz galvanisiert · Zinc die-cast black galvanized



PLANENBESCHLÄGE · TARPAULIN FITTINGS

Karabinerhaken Feuerwehr Carbine hook fire service



NR. no.	VE PU	Länge length	Material · material
12076	100 St.	40 mm	verzinkt · zinc plated
11972	100 St.	50 mm	verzinkt · zinc plated
11148	100 St.	60 mm	verzinkt · zinc plated
11149	100 St.	80 mm	verzinkt · zinc plated
11150	100 St.	100 mm	verzinkt · zinc plated
11151	100 St.	60 mm	Nirosta · INOX
11152	100 St.	80 mm	Nirosta · INOX
11971	100 St.	100 mm	Nirosta · INOX

Nicht zum Heben von Lasten geeignet!
Not suitable for lifting loads!

Kettenschnellverschluss Quick-action chain fastener



NR. no.	VE PU	Ø	Länge length	Material · material
11153	1 St.	5 mm	40 mm	Nirosta · INOX
11154	1 St.	8 mm	58 mm	Nirosta · INOX

Zurrgurthaken Lashing strap hook



NR. no.	VE PU	Breite width	Ausführung, Material description, material
10699	1 St.	25 mm	Drahhaken, verzinkt · wire hook, zinc plated
10700	1 St.	35 mm	Drahhaken, verzinkt · wire hook, zinc plated
10701	1 St.	50 mm	Drahhaken, verzinkt · wire hook, zinc plated
12146	1 St.	25 mm	Drahhaken, Nirosta · wire hook, INOX
12158	1 St.	35 mm	Drahhaken, Nirosta · wire hook, INOX
12159	1 St.	50 mm	Drahhaken, Nirosta · wire hook, INOX
12383	1 St.	25 mm	Drahhaken, Stahl schwarz (KTL beschichtet) wire hook, steel black (KTL coated)
10702	1 St.	58 mm	Klauenhaken, verzinkt · claw hook, zinc plated
10703	1 St.	50 mm	Karabinerhaken, verzinkt · carabine hook, zinc plated

Tornisterhaken Knapsack hook



NR. no.	VE PU	Breite width	Höhe height	Länge length	Ø I	*	Material material
11291	100 St.	28 mm	20 mm	38 mm	6 mm	4 mm	verzinkt zinc plated

S-Haken
S-hook



NR. no.	VE PU	Ø	Länge length	Material · material
10252	100 St.	3 mm	30 mm	verzinkt · zinc plated
10253	100 St.	4 mm	40 mm	verzinkt · zinc plated
10254	100 St.	4.2 mm	45 mm	verzinkt · zinc plated
10255	100 St.	6 mm	60 mm	verzinkt · zinc plated
10579	100 St.	4 mm	35 mm	Nirosta · INOX

Einhängehaken
Suspension hook



NR. no.	VE PU	Ø	Länge length	Material · material
10257	100 St.	4 mm	50 mm	verzinkt · zinc plated

Fahnenhalter, Kunststoff
Flag holder, plastic



NR. no.	VE PU	Breite width	Länge length	Farbe colour	Ausführung description
10740	100 / 1000 St.	23 mm	42 mm	weiß white	für 10 mm Gurtband for 10 mm web belts

Passendes Gurt- & Einfassband, siehe Seite 74 / 75.
For matching webbing and surround band, please see page 74 / 75.

Gurtschloss, für Gurtbänder
Belt buckle, for webbings



NR. no.	VE PU	Breite width	Farbe · colour	Ausführung, Material description, material
11143	100 St.	25 mm	schwarz · black	2-teilig, Kunststoff · 2-piece, plastic
11144	100 St.	50 mm	schwarz · black	2-teilig, Kunststoff · 2-piece, plastic

Schieber
Slider



NR. no.	VE PU	Breite width	Farbe · colour	Material · material
11145	100 St.	16 mm	schwarz · black	Kunststoff · plastic
11146	100 St.	25 mm	schwarz · black	Kunststoff · plastic
11158	100 St.	50 mm	schwarz · black	Kunststoff · plastic



PLANENBESCHLÄGE · TARPAULIN FITTINGS

Schleife, für Gurtbänder Loops, for webbing



NR. no.	VE PU	Breite width	Farbe · colour	Material · material
11147	100 St.	25 mm	schwarz · black	Kunststoff · plastic
10943	100 St.	50 mm	schwarz · black	Kunststoff · plastic

Klemmschloss, für Gurtbänder Camlock buckle, for webbings



NR. no.	VE PU	Breite width	Farbe · colour	Ausführung, Material description, material
11578	1 / 100 St.	20 mm		verzinkt · zinc plated
10616	1 / 100 St.	25 mm		verzinkt · zinc plated
12035	1 / 100 St.	25 mm	schwarz · black	Zink Druckguß schwarz galvanisiert Zinc die-cast black galvanized
11141	1 St.	35 mm		verzinkt · zinc plated
10897	1 St.	50 mm		verzinkt · zinc plated
11694	1 St.	25 mm		Nirosta · INOX
12013	1 / 100 St.	25 mm		beidseitige Gurtaufnahme, verzinkt belt attachment on both sides, zinc plated

Klemmschloss, mit vernähten Gurtbändern
Camlock buckle, with stitched webbing



NR. no.	VE PU	Breite width	Länge length	↔	Farbe · colour
11986	1 St.	18 mm	80 cm	150 daN	grau meliert · flecked with grey
11987	1 St.	20 mm	40 cm	180 daN	schwarz · black
11988	1 St.	25 mm	55 cm	250 daN	blau · blue
11989	1 St.	25 mm	250 cm	250 daN	schwarz · black
11990	1 St.	25 mm	300 cm	250 daN	schwarz · black
11991	1 St.	25 mm	300 cm	250 daN	weiß · white
11992	1 St.	25 mm	400 cm	250 daN	schwarz · black
11993	1 St.	25 mm	450 cm	250 daN	weiß · white
11994	1 St.	25 mm	450 cm	250 daN	schwarz · black
11995	1 St.	25 mm	500 cm	250 daN	schwarz · black
11996	1 St.	25 mm	600 cm	250 daN	schwarz · black

Gummi-Spannring
Rubber tensioning ring



NR. no.	VE PU	Länge length	Farbe · colour	Ausführung, Material description, material
10162	100 St.	200 mm	schwarz · black	UV-stabil, EPDM · UV-proof, EPDM
10163	100 St.	250 mm	schwarz · black	UV-stabil, EPDM · UV-proof, EPDM
10164	100 St.	400 mm	schwarz · black	UV-stabil, EPDM · UV-proof, EPDM
12319	100 St.	200 mm	transparent	UV-stabil, EPDM · UV-proof, EPDM
12320	100 St.	250 mm	transparent	UV-stabil, EPDM · UV-proof, EPDM
12321	100 St.	400 mm	transparent	UV-stabil, EPDM · UV-proof, EPDM
10652	100 St.	200 mm	schwarz · black	mit S-Haken 45 x 4.2 mm, UV-stabil, EPDM · with S-hook 45 x 4.2 mm, UV-proof, EPDM
10861	100 St.	250 mm	schwarz · black	mit S-Haken 45 x 4.2 mm, UV-stabil, EPDM · with S-hook 45 x 4.2 mm, UV-proof, EPDM
10862	100 St.	400 mm	schwarz · black	mit S-Haken 45 x 4.2 mm, UV-stabil, EPDM · h S-hook 45 x 4.2 mm, UV-proof, EPDM
10698	100 / 1000 St.	65 mm	crème / weiß creamy white	Plakathalter, EPDM · poster holder, EPDM
10166	100 St.	140 mm	schwarz · black	Naturkautschuk · natural rubber
11844	100 / 1000 St.	80 mm	grau · grey	z. B. als Zeltspannrings verwendbar, Naturkautschuk · can be used e.g. as tent tension rings, natural rubber
11845	100 St.	120 mm	grau · grey	
10251	100 / 1000 St.	140 mm	grau · grey	

PLANENBESCHLÄGE · TARPAULIN FITTINGS

Gummistroppe Rubber tensioning ring



NR. no.	VE PU	Länge length	Farbe · colour	Ausführung, Material description, material
11368	100 St.	280 mm	weiß · white	4-stufig verstellbar, UV-stabil, EPDM 4-loop adjustment, UV-proof, EPDM
11820	100 St.	280 mm	schwarz · black	4-stufig verstellbar, UV-stabil, EPDM 4-loop adjustment, UV-proof, EPDM
12415	100 St.	265 mm	schwarz · black	4-stufig verstellbar, UV-stabil, EPDM stabil/4-loop adjustment, UV-proof, EPDM
11770	100 St.	190 mm	weiß · white	2-stufig verstellbar, UV-stabil, EPDM 2-loop adjustment, UV-proof, EPDM
10165	100 St.	285 mm	schwarz · black	3-stufig verstellbar, UV-stabil, Naturkautschuk · 3-loop adjustment, UV-proof, natural rubber
10643	100 St.	180 mm	schwarz · black	1-stufig, UV-stabil, EPDM 1-loop, UV-proof, EPDM
10644	100 St.	250 mm	schwarz · black	1-stufig, UV-stabil, EPDM 1-loop, UV-proof, EPDM

Leitergummi Continuous Chain Tensioner



NR. no.	VE PU	Breite width	Länge length	Farbe · colour	Material · material
10837	1 St.	30 mm	10 m	schwarz · black	Naturkautschuk natural rubber

Riemenkrampe, verzinkt Strap cramp, zinc plated



NR. no.	VE PU	Breite width	Höhe height	Länge length	Ø I	↔	Ausführung description
10443	100 St.	15 mm	11 mm	49 mm	15 mm	34 mm	klein (VW) small (VW)
10444	100 St.		15 mm				klein (VW) small (VW)
10445	100 St.		17 mm				klein (VW) small (VW)
10439	100 St.		16 mm	66 mm	26 mm	51 mm	groß · large
10440	100 St.		20 mm				groß · large
10441	100 St.		25 mm				groß · large
10442	100 St.		30 mm				groß · large
10543	100 St.		35 mm				groß · large

Lakeikrampe, Messing vernickelt Tilt cramp, brass nickel plated



NR. no.	VE PU	Breite width	Höhe height	Länge length	Ø I	↔	
10633	100 St.	12 mm	14 mm	58 mm	20 mm	44 mm	

Flachkrampe, verzinkt
Flat cramp, zinc plated

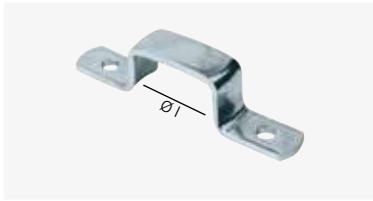

NR. no.	VE PU	Breite width	Höhe height	Länge length	Ø I	↔	Ausführung description
10660	100 St.	13 mm	16 mm	78 mm	28 mm	57 mm	für Ovalösen 42 x 22 mm for oval eyelets 42 x 22 mm

Bügelkrampe, Standard
Rounded staple, standard



NR. no.	VE PU	Breite width	Höhe height	Länge length	Ø I	↔	Material material
10454	100 St.	20 mm	21 mm	71 mm	20 mm	51 mm	verzinkt · zinc plated
10455	100 St.	20 mm	25 mm		20 mm	51 mm	verzinkt · zinc plated
10456	100 St.	20 mm	30 mm		20 mm	51 mm	verzinkt · zinc plated
10457	100 St.	20 mm	38 mm		20 mm	51 mm	verzinkt · zinc plated
10458	100 St.	20 mm	45 mm		20 mm	51 mm	verzinkt · zinc plated
10459	100 St.	20 mm	55 mm		20 mm	51 mm	verzinkt · zinc plated
11297	100 St.	16 mm	30 mm		25 mm	51 mm	Nirosta · INOX

Bügelkrampe
Rounded staple



NR. no.	VE PU	Breite width	Höhe height	Länge length	Ø I	↔	Material material
11536	100 St.	15 mm	30 mm	66 mm	25 mm	51 mm	verzinkt zinc plated

Bügelkrampe, mit 8-eckiger Platte
Rounded staple, with 8-angled plate



NR. no.	VE PU	Breite width	Höhe height	Länge length	Ø I	↔	Material material
10822	100 St.	40 mm	25 mm	65 mm	20 mm	40 mm	verzinkt zinc plated
10820	100 St.		30 mm				verzinkt zinc plated



Bügelkrampe klein Staple small



NR. no.	VE PU	Breite width	Höhe height	Länge length	Ø I	↔	Ausführung description
11424	100 St.	32 mm	22 mm	53 mm	13 mm	40 mm	für Ø 25 mm Ösen, verzinkt for Ø 25 mm eyelets, zinc plated
11425	100 St.		30 mm				verzinkt zinc plated

Bügelkrampe, mit quadratischer Platte Rounded staple, with square plate



NR. no.	VE PU	Breite width	Höhe height	Länge length	Ø I	↔	Material material
11170	100 St.	40 mm	25 mm	40 mm	20 mm	26 mm	verzinkt zinc plated
10819	100 St.		30 mm				verzinkt zinc plated

Bügelkrampen, mit Nase Rounded staples, with nose



NR. no.	VE PU	Breite width	Höhe height	Länge length	Ø I	↔	Material material
10821	100 St.	16 mm	30 mm	76 mm	28 mm	55 mm	verzinkt zinc plated

Bügelkrampe, zum umklappen Rocking staple, to fold

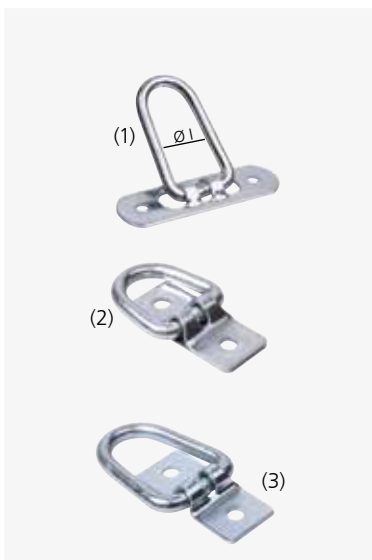

NR. no.	VE PU	Breite width	Höhe height	Länge length	Ø I	↔	Ausführung description
10460	100 St.	22 mm	25 mm	72 mm	20 mm	51 mm	nach Zollvorschrift, verzinkt (1) in acc. with customs regulations, zinc plated (1)
10461	100 St.	22 mm	37 mm	72 mm	21 mm	51 mm	
10462	100 St.	22 mm	45 mm	72 mm	23 mm	51 mm	
10463	100 St.	22 mm	55 mm	72 mm	23 mm	51 mm	
10464	100 St.	20 mm	25 mm	46 mm	22 mm	30 mm	nach Zollvorschrift, verzinkt (2) in acc. with customs regulations, zinc plated (2)
10465	100 St.	20 mm	37 mm	46 mm	22 mm	30 mm	
10466	100 St.	20 mm	45 mm	46 mm	24 mm	30 mm	
10467	100 St.	20 mm	55 mm	46 mm	23 mm	30 mm	
10468	100 St.	20 mm	25 mm	46 mm	21 mm	30 mm	verzinkt (3) zinc plated (3)
10469	100 St.	20 mm	37 mm	46 mm	21 mm	30 mm	

Rundring, geschweisst
Round ring, welded



NR. no.	VE PU	Ø	Ø I	Material · material
11762	100 St.	3 mm	20 mm	verzinkt · zinc plated
11763	100 St.	3 mm	25 mm	verzinkt · zinc plated
10260	100 St.	3 mm	30 mm	verzinkt · zinc plated
10261	100 St.	5 mm	40 mm	verzinkt · zinc plated
10262	100 St.	5 mm	50 mm	verzinkt · zinc plated
10263	100 St.	5 mm	60 mm	verzinkt · zinc plated
10264	100 St.	5 mm	70 mm	verzinkt · zinc plated
10578	100 St.	6 mm	50 mm	Nirosta · INOX

Halbrundringe, geschweißt
Half-round ring, welded



NR. no.	VE PU	Ø	Ø I	Farbe · colour	Material · material
10944	100 St.	3.2 mm	20 mm		verzinkt · zinc plated
10942	100 St.	3.2 mm	22 mm	schwarz · black	verzinkt schwarz chromatiert zinc plated black chromated
10275	100 St.	4 mm	25 mm		verzinkt · zinc plated
12034	100 St.	4 mm	34 mm	schwarz · black	
11042	100 St.	5 mm	30 mm		verzinkt · zinc plated
11043	100 St.	5 mm	35 mm		verzinkt · zinc plated
11084	100 St.	5 mm	40 mm		verzinkt · zinc plated
10577	100 St.	5 mm	45 mm		verzinkt · zinc plated
11040	100 St.	5 mm	50 mm		verzinkt · zinc plated
11416	100 St.	4 mm	25 mm		Nirosta · INOX
11415	100 St.	5.8 mm	50 mm		Nirosta · INOX

Ringhalter
Ring holder



NR. no.	VE PU	↔	Material · material
10258	100 / 1000 St.	20 mm	verzinkt · zinc plated
12128	100 St.	20 mm	Nirosta · INOX

Ringklaue, verzinkt
Ring claw, zinc plated



NR. no.	VE PU	Ausführung · description
10277	100 / 1000 St.	1-Loch (wird zusammengepresst und mit einem Niet geschlossen) 1-hole (will be pressed together and closed with a rivet)
10259	100 / 1000 St.	2-Loch · 2-hole





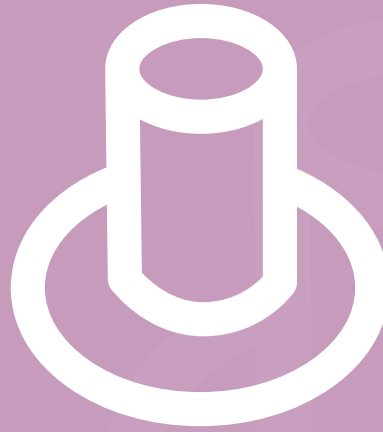
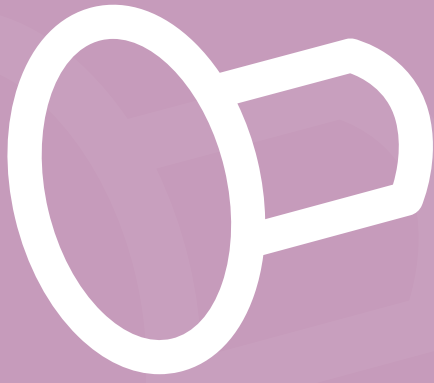

NIETEN
RIVETS



Doppel-Calott · double calotte



Einfach-Calott · single calotte

Hohlriete

Tubular (hollow) rivet



NR. no.	VE PU	Ø	Länge length	Ausführung, Material description, material
10778	2500 St.	6 mm	6 mm	Doppel-Calott, Messing vernickelt double calotte, brass nickel plated
10704	2500 St.	10 mm	10 mm	Einfach-Calott, verzinkt single calotte, zinc plated
10705	2500 St.	10 mm	10 mm	Doppel-Calott, verzinkt double calotte, zinc plated
10709	2500 St.	10 mm	10 mm	Doppel-Calott, Messing double calotte, brass
10710	2500 St.	10 mm	10 mm	Doppel-Calott, Messing vernickelt double calotte, brass nickel plated
10276	2500 St.	10 mm	10 mm	Doppel-Calott, Messing schwarz brüniert double calotte, brass black burnished
10280	2500 St.	13 mm	12 mm	Einfach-Calott, verzinkt single calotte, zinc plated
10281	2500 St.	13 mm	12 mm	Doppel-Calott, verzinkt double calotte, zinc plated
10755	2500 St.	13 mm	12 mm	Einfach-Calott, Messing single calotte, brass
10604	2500 St.	13 mm	12 mm	Doppel-Calott, verzinkt double calotte, zinc plated
10756	2500 St.	13 mm	12 mm	Einfach-Calott, Messing vernickelt single calotte, brass nickel plated
10408	2500 St.	13 mm	12 mm	Doppel-Calott, Messing vernickelt double calotte, brass nickel plated
11303	2500 St.	13 mm	12 mm	Doppel-Calott, Messing schwarz brüniert double calotte, brass black burnished
10712	2500 St.	13 mm	14 mm	Einfach-Calott, verzinkt single calotte, zinc plated
10713	2500 St.	13 mm	14 mm	Doppel-Calott, verzinkt double calotte, zinc plated
10716	2500 St.	13 mm	14 mm	Doppel-Calott, Messing vernickelt double calotte, brass nickel plated

Die Länge der Hohlrieten sollte ca. 3 mm länger sein als das zu vernietende Material.
The length of the tubular rivets should be approx. 3 mm longer than the material to be riveted.

Selbstlochende Riete

Self-cutting rivet



NR. no.	VE PU	Ø	Länge length	Material material
11249	1000 St.	9.2 mm	9 mm	Messing vernickelt · brass nickel plated
11250	1000 St.		10.5 mm	Messing vernickelt · brass nickel plated

Passende Nietendöpper, siehe Seite 167.
for matching rivet devices, see page 167.

Mehrbereichblindniete, Kopf Ø 9,5 mm
Multi-range blind rivet, head Ø 9,5 mm



NR. no.	VE PU	Ø	Länge length	Ausführung, Material description, material
10757	500 St.	4.8 mm	10.3 mm	Klemmbereich 1.6 - 6.4 mm, Alu/Stahl clamping area 1.6 - 6.4 mm, aluminium/steel
10758	500 St.	4.8 mm	15.1 mm	Klemmbereich 4.5 - 11 mm, Alu/Stahl clamping area 4.5 - 11 mm, aluminium/steel
10762	500 St.	4.8 mm	16.9 mm	Klemmbereich 6.5 - 13 mm, Alu/NIROSTA clamping area 6.5 - 13 mm, aluminium/stainless steel

Mehrbereichblindniete, Großkopf Ø 16 mm
Multi-range blind rivet, big head Ø 16 mm



NR. no.	VE PU	Ø	Länge length	Ausführung, Material description, material
10763	250 St.	4.8 mm	10.3 mm	Klemmbereich 1.6 - 6.4 mm, Alu/Stahl clamping area 1.6 - 6.4 mm, aluminium/steel
11492	250 St.		12 mm	Klemmbereich 4 - 9.5 mm, Alu/Stahl clamping area 4 - 9.5 mm, aluminium/steel
10764	250 St.		17 mm	Klemmbereich 4.5 - 11 mm, Alu/Stahl clamping area 4.5 - 11 mm, aluminium/steel
10765	250 St.		10.5 mm	Klemmbereich 1.5 - 6.0 mm, Alu/NIROSTA clamping area 1.5 - 6.0 mm, aluminium/stainless steel
10766	250 St.		16.9 mm	Klemmbereich 6.5 - 12.5 mm, Alu/NIROSTA clamping area 6.5 - 12.5 mm, aluminium/stainless steel

Blindniete, Kopf Ø 8 mm
Blind rivet, head Ø 8 mm



NR. no.	VE PU	Ø	Länge length	Ausführung, Material description, material
11222	1000 St.	4 mm	8 mm	Klemmbereich 3 - 5 mm, Alu/Stahl clamping area 3 - 5 mm, aluminium/steel
11223	1000 St.	4 mm	12 mm	Klemmbereich 6.5 - 8.5 mm, Alu/Stahl clamping area 6.5 - 8.5 mm, aluminium/steel

Blindniete, Kopf Ø 9 mm
Blind rivet, head Ø 9 mm



NR. no.	VE PU	Ø	Länge length	Ausführung, Material description, material
10767	500 St.	4.8 mm	6 mm	Klemmbereich 1 - 3 mm, Alu/Stahl clamping area 1 - 3 mm, aluminium/steel
10768	500 St.	4.8 mm	8 mm	Klemmbereich 3 - 4.5 mm, Alu/Stahl clamping area 3 - 4.5 mm, aluminium/steel
10769	500 St.	4.8 mm	10 mm	Klemmbereich 4.5 - 6 mm, Alu/Stahl clamping area 4.5 - 6 mm, aluminium/steel
10770	500 St.	4.8 mm	12 mm	Klemmbereich 6 - 8 mm, Alu/Stahl clamping area 6 - 8 mm, aluminium/steel
10771	500 St.	4.8 mm	14 mm	Klemmbereich 8 - 10 mm, Alu/Stahl clamping area 8 - 10 mm, aluminium/steel
10775	500 St.	4.8 mm	20 mm	Klemmbereich 14 - 17 mm, Alu/Stahl clamping area 14 - 17 mm, aluminium/steel

Dichtblindniete, Kopf Ø 9,5 mm
Sealed blind rivet, head Ø 9,5 mm



NR. no.	VE PU	Ø	Länge length	Ausführung, Material description, material
10776	250 St.	4.8 mm	11 mm	Klemmbereich 5 - 6.5 mm, Alu/Stahl clamping area 5 - 6.5 mm, aluminium/steel

NIETEN · RIVETS

Hochfeste Niete Strong rivet



NR. no.	VE PU	Ø	Länge length	Ausführung, Material description, material
10809	250 St.	6.4 mm	14.5 mm	Klemmbereich 6.8 - 8.8 mm, Stahl clamping area 6.8 - 8.8 mm, steel
11370	250 St.		16.5 mm	clamping area 8.8 - 10.8 mm, Stahl clamping area 8.8 - 10.8 mm, steel

zum Vernieten von Spannern und Rollen
for riveting of buckles and rollers

Bolzen Bolts



NR. no.	VE PU	Ausführung, Material description, material
10955	500 St.	Klemmbereich 3.2 - 6.4 mm, Aluminium clamping area 3.2 - 6.4 mm, aluminium
10956	500 St.	clamping area 4.8 - 7.9 mm, Aluminium clamping area 4.8 - 7.9 mm, aluminium
10963	500 St.	Klemmbereich 4.8 - 7.9 mm, Nirosta clamping area 4.8 - 7.9 mm, INOX

zum Vernieten von Spannern und Rollen
for riveting of buckles and rollers

Passende Nietgeräte, siehe Seite 166.
For matching rivet devices, see page 166.

Schliessring Closing ring



NR. no.	VE PU	Material · material
10957	500 St.	Aluminium · aluminium
10964	500 St.	Nirosta · INOX

Alu-Vollniete, Kopf Ø 9 mm (DIN 674) Alu-full rivet, head Ø 9 mm (DIN 674)



NR. no.	VE PU	Ø	Länge length	Ausführung description
11429	500 St.	5 mm	8 mm	Klemmbereich 2 - 4.5 mm clamping area 2 - 4.5 mm
11430	500 St.		10 mm	Klemmbereich 4 - 6.5 mm clamping area 4 - 6.5 mm
11431	500 St.		12 mm	Klemmbereich 6 - 8.5 mm clamping area 6 - 8.5 mm
11432	500 St.		15 mm	Klemmbereich 9 - 11.5 mm clamping area 9 - 11.5 mm
11433	500 St.		20 mm	Klemmbereich 12 - 16.5 mm clamping area 12 - 16.5 mm
11434	500 St.		30 mm	Klemmbereich 22 - 26.5 mm clamping area 22 - 26.5 mm
11435	500 St.		35 mm	Klemmbereich 25 - 30 mm clamping area 25 - 30 mm

Für Zollbeschlüge.
For custom fittings.

Alu-Riemenniete, Kopf Ø 11 mm (DIN 675)
Alu-strap rivet, head Ø 11 mm (DIN 675)



NR. no.	VE PU	Ø	Länge length	Ausführung · description
11443	500 St.	4 mm	8 mm	Klemmbereich 2 - 4.5 mm clamping area 2 - 4.5 mm
11438	500 St.		10 mm	Klemmbereich 4 - 6.5 mm clamping area 4 - 6.5 mm
11439	500 St.		12 mm	Klemmbereich 6 - 8.5 mm clamping area 6 - 8.5 mm
11440	500 St.		15 mm	Klemmbereich 9 - 11.5 mm clamping area 9 - 11.5 mm
11442	500 St.		20 mm	Klemmbereich 12 - 16.5 mm clamping area 12 - 16.5 mm

Für Zollbeschläge.
 For custom fittings.

Nietscheibe
Back plate



NR. no.	VE PU	Ø	*	Ø O	Ausführung, Material description, material
11436	1000 St.	15 mm	1 mm	5 mm	für Vollnieten, verzinkt for full rivets, zinc plated
11444	500 St.	12 mm		4 mm	für Alu-Riemennieten, verzinkt for aluminium-strap rivets, zinc plated
11445	500 St.	12 mm		4 mm	für Alu-Riemennieten, Aluminium for aluminium-strap rivets, aluminium

Unterlegscheibe, für Blindnieten
Washer, for blind rivets



NR. no.	VE PU	Ø	Ø O	Material material
11315	1000 St.	10 mm	5.3 mm	verzinkt · zinc plated
10804	1000 St.	22 mm	7.4 mm	verzinkt · zinc plated

Nietunterlage, aus Riemenmaterial
Washer, made of strap material



NR. no.	VE PU	↔	*	Ø O	Farbe · colour	Ausführung description
10099	1000 St.		2.1 mm	3 mm	weiß · white	1-Loch · 1-hole
10064	1000 St.			3 mm	beige · beige	1-Loch · 1-hole
12050	1000 St.			3 mm	schwarz · black	1-Loch · 1-hole
10065	500 St.	20 mm		3 mm	beige · beige	2-Loch · 2-hole
10098	500 St.	20 mm		3 mm	weiß · white	2-Loch · 2-hole
10066	500 St.	25 mm		3 mm	beige · beige	2-Loch · 2-hole
10622	500 St.	25 mm		3 mm	weiß · white	2-Loch · 2-hole
10391	100 St.	34 mm		3 mm	beige · beige	2-Loch · 2-hole



Nietunterlage aus Kunststoff (PE)

Washer made of plastic (PE)



NR. no.	VE PU	↔	*	Ø O	Farbe · colour	Ausführung description
10008	1000 St.		2.5 mm	4 mm	transparent	1-Loch · 1-hole
10278	500 St.	20 mm		4 mm	transparent	2-Loch · 2-hole
11766	500 St.	25 mm		4 mm	transparent	2-Loch · 2-hole
10021	500 St.	34 mm		4 mm	transparent	2-Loch · 2-hole
10097	500 St.	51 mm		4 mm	transparent	2-Loch · 2-hole

Nietunterlage, aus Kunststoff (PA6)

Washer, made of plastic (PA6)



NR. no.	VE PU	Höhe height	↔	Farbe · colour	Ausführung · description
10103	500 St.	12 mm	20 mm	silber · silver	mit selbstlochenden Nieten, Messing vernickelt with self-piercing rivets, brass nickel plated
10112	500 St.	12 mm	20 mm	weiß · white	
11630	500 St.	9 mm	20 mm	weiß · white	
11652	500 St.	9 mm	34 mm	weiß · white	
10168	500 St.	9 mm	51 mm	weiß · white	
12136	500 St.	12 mm	51 mm	weiß · white	

Gegenplatte Twinfix mit selbstsichernden Muttern

Twinfix counter plate, with self-securing nuts



NR. no.	VE PU	Breite width	Länge length	↔	Ausführung, Material description, material
10142	100 / 500 St.	20 mm	45 mm	28 mm	Schraubenlänge 12 mm, Nirosta screw length 12 mm, INOX
10617	100 / 500 St.	20 mm	45 mm	28 mm	Schraubenlänge 14 mm, Nirosta screw length 14 mm, INOX
11769	100 St.	20 mm	45 mm	28 mm	Schraubenlänge 16 mm, Nirosta screw length 16 mm, INOX
11248	100 St.				lose selbstsichernde Muttern M6, Nirosta loose self-locking nuts M6, INOX

Andere Gewinde-Abstände fertigen wir gerne auf Anfrage.
We also supply counterplates with other thread spacings on demand.

Nirosta-Gegenplatte

Inox counter plate



NR. no.	VE PU	Breite width	Länge length	↔	Ausführung, Material description, material
11892	100 St.	20 mm	45 mm	28 mm	Schraubenlänge 14 mm, mit M6 Mutter mit Sperrverzahnung, Nirosta · screw length 14 mm, with M6 nut with locking teeth, INOX
11893	100 St.				lose M6 Muttern mit Sperrverzahnung, Nirosta · loose M6 nuts with locking teeth, INOX

Gegenplatte
Counter plate



NR. no.	VE PU	Breite width	Länge length	Ø O	↔	Material material
11479	100 St.	18 mm	34 mm	5.4 mm	20 mm	verzinkt · zinc plated
11480	100 St.	20 mm	45 mm	5.4 mm	25 mm	verzinkt · zinc plated
12422	100 St.	20 mm	45 mm	6.8 mm	28 mm	verzinkt · zinc plated
10689	100 St.	20 mm	45 mm	6.8 mm	28 mm	Nirosta · INOX
10806	100 St.	15 mm	50 mm	5 mm	34 mm	Nirosta · INOX
11822	100 St.	20 mm	45 mm	6 mm	28 mm	verzinkt · zinc plated
11481	100 St.	15 mm	50 mm	5 mm	34 mm	verzinkt · zinc plated
11167	100 St.	20 mm	70 mm	5 mm	51 mm	verzinkt · zinc plated

Gegenplatte, aus Kunststoff
Counter plate, made of plastic



NR. no.	VE PU	Breite width	Höhe height	Länge length	Ø O	↔	Farbe colour
11880	100 St.	25 mm	5 mm	65 mm	5.3 mm	36 mm	schwarz · black





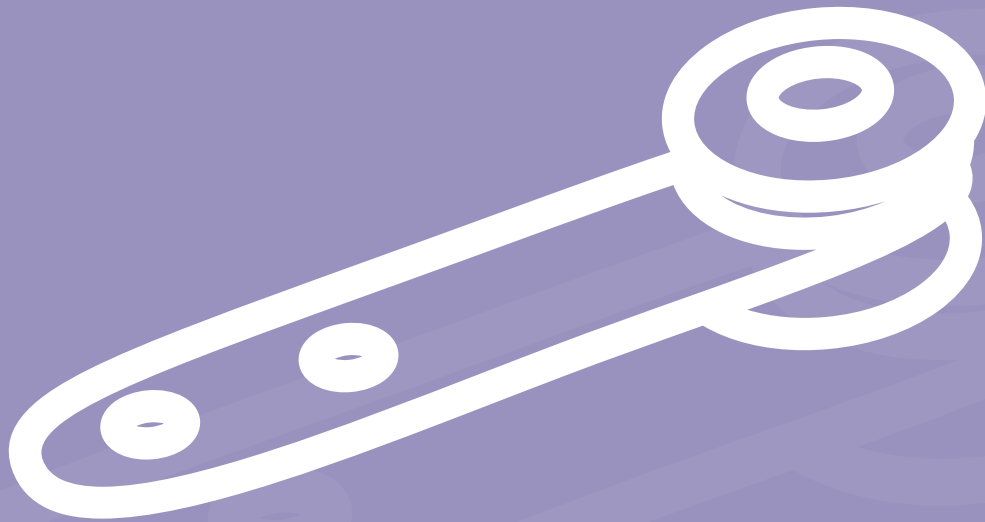

SCHIEBEPLANEN- SYSTEME

SIDE CURTAIN SYSTEMS



SCHIEBEPLANENSYSTEME · SIDE CURTAIN SYSTEMS

Rolle, mit Kugellager „Standard“

Roller, with ball bearing "standard"



NR. no.	VE PU	Breite width	Länge length	↔	*	Ø Rolle Ø roll	Breite Rolle width of roll
10211	1 / 50 St.	40 mm	128 mm	28 mm	5 mm	35 mm	31 mm

Rolle, mit Kugellager „gekröpft“

Roller, with ball bearing "angled"



NR. no.	VE PU	Breite width	Länge length	↔	*	Ø Rolle Ø roll	Breite Rolle width of roll
10435	1 / 50 St.	40 mm	122 mm	28 mm	5 mm	34 mm	28 mm

Rolle, mit Kugellager „waagrecht“

Roller, with ball bearing "horizontal"



NR. no.	VE PU	Breite width	Länge length	↔	Ø Rolle · Ø roll	Breite Rolle width of roll
10421	1 / 50 St.	45 mm	105 mm	28 mm	34 mm	28 mm

Rolle, mit Kugellager

Roller, with ball bearing

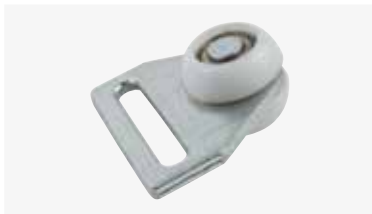

NR. no.	VE PU	Breite width	Länge length	*	Ø Rolle Ø roll	Breite Rolle width of roll	Ausführung description
10436	1 / 50 St.	65 mm	65 mm	5 mm	34 mm	28 mm	mit Schlitz für 50 mm Gurtband with slot for 50 mm webbing

Stahlrolle, mit Gleitlager

Steel roller, with sliding-bearing



NR. no.	VE PU	Breite width	Länge length	↔	*	Ø Rolle Ø roll	Breite Rolle width of roll
10212	1 / 50 St.	30 mm	120 mm	28 mm	4 mm	38 mm	28 mm

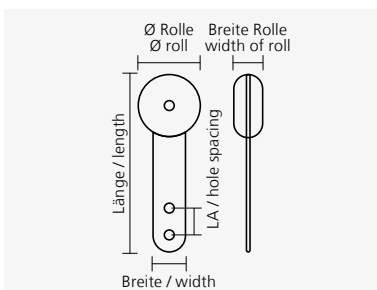

Rolle, mit Kugellager Roller, with ball bearing



NR. no.	VE PU	Breite width	Länge length	↔	*	Ø Rolle Ø roll	Breite Rolle width of roll
10446	1 / 50 St.	40 mm	125 mm	28 mm	5 mm	37 mm	28 mm

Rolle, mit Kugellager Roller, with ball bearing

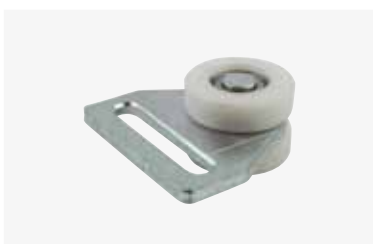

NR. no.	VE PU	Breite width	Länge length	*	Ø Rolle Ø roll	Breite Rolle width of roll	Ausführung description
10449	1 / 50 St.	65 mm	62 mm	5 mm	37 mm	28 mm	für gerade Profile, mit Schlitz für 50 mm Gurtband for straight profiles, with slot for 50 mm webbing

Rolle, mit Kugellager Roller, with ball bearing



NR. no.	VE PU	Breite width	Länge length	↔	*	Ø Rolle Ø roll	Breite Rolle width of roll	Ausführung description
10690	1 / 50 St.	40 mm	105 mm	28 mm	5 mm	37 mm	28 mm	für gerade Aluprofile for straight aluminium profiles

Rolle, mit Kugellager Roller, with ball bearing



NR. no.	VE PU	Breite width	Länge length	↔	*	Ø Rolle Ø roll	Breite Rolle width of roll	Ausführung description
10544	1 / 50 St.	30 mm	120 mm	28 mm	3 mm	31 mm	25 mm	für kleine Aluprofile for small aluminium profiles

Doppelrolle, mit Kugellager Double roller, with ball bearing



NR. no.	VE PU	Breite width	Länge length	*	Ø Rolle Ø roll	Breite Rolle width of roll	Ausführung description
10917	1 / 50 St.	75 mm	55 mm	5 mm	31 mm	19 mm	einseitig, mit Schlitz für 50 mm Gurtband single-sided, with slot for 50 mm webbing

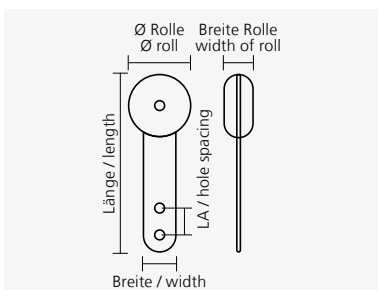

SCHIEBEPLANENSYSTEME · SIDE CURTAIN SYSTEMS

Doppelrolle, aus Stahl Steel double roller



NR. no.	VE PU	Breite width	Länge length	↔	Ø Rolle Ø roll	Breite Rolle width of roll	Ausführung description
10634	1 / 50 St.	65 mm	70 mm	28 mm	29 mm	25 mm	mit Stahlkugellager „gekröpft“ with steel ball bearing „angled“

Doppelrolle Double roller



NR. no.	VE PU	Breite width	Länge length	↔	✱	Ø Rolle Ø roll	Breite Rolle width of roll	Ausführung description
10883	1 / 50 St.	65 mm	60 mm	28 mm	5 mm	30 mm	26 mm	mit Kunststoff-Kugellager „gekröpft“ with plastic ball bearing „angled“

Rolle, mit Kugellager Roller, with ball bearing



NR. no.	VE PU	Breite width	Länge length	↔	✱	Ø Rolle Ø roll	Breite Rolle width of roll
10882	1 / 50 St.	30 mm	115 mm	28 mm	3 mm	31 mm	24 mm

Rolle, mit Kugellager Roller, with ball bearing



NR. no.	VE PU	Breite width	Länge length	✱	Ø Rolle Ø roll	Breite Rolle width of roll	Ausführung description
11535	1 / 50 St.	40 mm	150 mm	5 mm	34 mm	28 mm	lange Ausführung, mit Schlitz für 50 mm Gurte long version, with slot for 50 mm webbing

Doppelrolle Trike Double Roller Trike



NR. no.	VE PU	Breite width	Länge length	✱	Ø Rolle Ø roll	Ausführung description
12127	1 / 50 St.	75 mm	60 mm	5 mm	32 mm / 22 mm	einseitig, mit Kugellager, mit Schlitz für 50 mm Gurtband one-sided, with ball bearing, with slit for 50 mm webbing

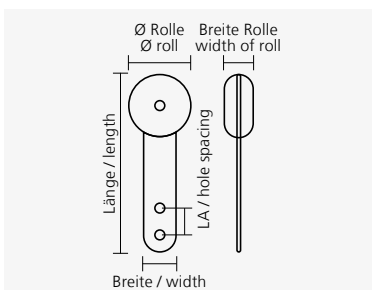

Dichtlippe Nr. 2

Pelmet No. 2

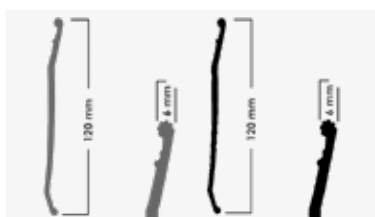

NR. no.	VE PU	Höhe height	Länge length	Farbe · colour	
11583	1 St.	120 mm	14 m	grau · grey	
11584	1 St.	120 mm	14 m	schwarz · black	

Dichtlippe Nr. 4

Pelmet No. 4



NR. no.	VE PU	Höhe height	Länge length	Farbe · colour	
11715	1 St.	130 mm	8.5 m	grau · grey	
11716	1 St.		14 m	grau · grey	
11717	1 St.		8.5 m	schwarz · black	
11718	1 St.		14 m	schwarz · black	

Dichtlippe Nr. 6

Pelmet No. 6



NR. no.	VE PU	Höhe height	Länge length	Farbe · colour	
11719	1 St.	120 mm	8.5 m	grau · grey	
11720	1 St.		14 m	grau · grey	
11721	1 St.		8.5 m	schwarz · black	
11722	1 St.		14 m	schwarz · black	

Dichtlippe Nr. 7

Pelmet No. 7

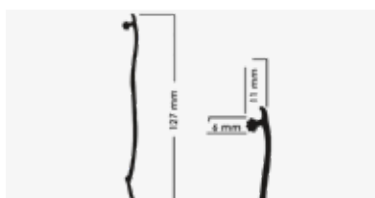

NR. no.	VE PU	Höhe height	Länge length	Farbe · colour	
11588	1 St.	127 mm	14 m	schwarz · black	

Dichtlippe Nr. 9

Pelmet No. 9



NR. no.	VE PU	Höhe height	Länge length	Farbe · colour	
11589	1 St.	130 mm	28 m	schwarz · black	

Dichtlippe Nr. 33

Pelmet No. 33



NR. no.	VE PU	Höhe height	Länge length	Farbe · colour	
11711	1 St.	120 mm	8.5 m	grau · grey	
11712	1 St.		14 m	grau · grey	
11713	1 St.		8.5 m	schwarz · black	
11714	1 St.		14 m	schwarz · black	



1-Loch Vorhangrolle für Profil Nr. 13

1-Hole curtain track roller for profile no. 13



NR. no.	VE PU	Breite width	Länge length	Ø Rolle Ø roll	Breite Rolle width of roll	Ausführung, Material description, material
10299	1 / 100 St.	17 mm	30 mm	16 mm	15 mm	für den Innenbereich, Kunststoff · for Indoor, plastic
12340	1 / 100 St.					Für den Außenbereich, mit Edelstahlvernietung, Kunststoff · For Outdoor, with stainless steel riveting, plastic

1-Loch Vorhangrolle für Profil Nr. 45

1-Hole curtain track roller for profile no. 45



NR. no.	VE PU	Breite width	Länge length	Ø Rolle Ø roll	Breite Rolle width of roll	Ausführung, Material description, material
10300	1 / 100 St.	18 mm	43 mm	20 mm	19 mm	mit Kugellager, Kunststoff with ball bearing, plastic
11407	1 / 100 St.					ohne Kugellager, Kunststoff without ball bearing, plastic

1-Loch Vorhangrolle für Profil Nr. 100

1-Hole curtain track roller for profile no. 100



NR. no.	VE PU	Breite width	Länge length	Ø Rolle Ø roll	Breite Rolle width of roll	Ausführung, Material description, material
10301	1 / 100 St.	19 mm	45 mm	22 mm	21 mm	mit Kugellager, Kunststoff with ball bearing, plastic
11408	1 / 100 St.					ohne Kugellager, Kunststoff without ball bearing, plastic

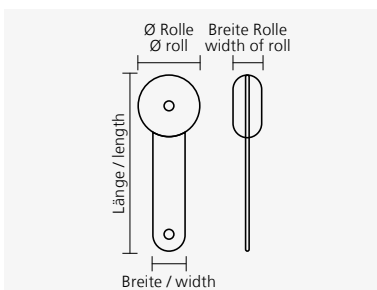

1-Loch Vorhangrolle, mit Stahlkugellager 1-Hole curtain track roller, with steel ball bearing



NR. no.	VE PU	Breite width	Länge length	Ø Rolle Ø roll	Breite Rolle width of roll	Ausführung description
11105	1 St.	25 mm	58 mm	20 mm	19 mm	für Profil No. 45 for profile No. 45
11106	1 St.	20 mm	57 mm	22 mm	21 mm	für Profil Nr. 100 for profile No. 100

Doppelrolle aus Kunststoff Double runner plastic



NR. no.	VE PU	Breite width	Länge length	↔	Ø Rolle Ø roll	Breite Rolle width of roll	Ausführung description
11102	1 St.	40 mm	29 mm	30 mm	16 mm	15 mm	ohne Kugellager, für Profil Nr. 13 without ball bearing, for profile No. 13
11103	1 St.	52 mm	43 mm	40/ 16 mm	20 mm	19 mm	ohne Kugellager, für Profil Nr. 45 without ball bearing, for profile No. 45
11104	1 St.	57 mm	43 mm	44/ 22 mm	22 mm	21 mm	mit Kugellager, für Profil Nr. 100 with ball bearing, for profile No. 100

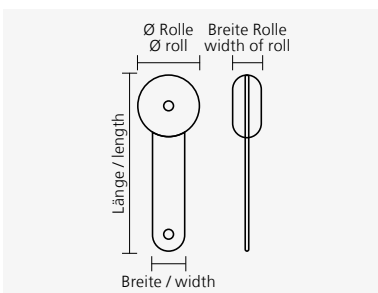

SCHIEBEPLANENSYSTEME · SIDE CURTAIN SYSTEMS

Vorhangrolle für Profil Nr. 45, zum Vernieten

Curtain track roller for profile no. 45, for riveting



NR. no.	VE PU	Breite width	Länge length	↔	*	Ø Rolle Ø roll	Breite Rolle width of roll	Ausführung description
10309	1 / 100 St.	20 mm	70 mm	20 mm	5 mm	20 mm	19 mm	mit Kugellager, Kunststoff with ball bearing, plastic
11409	1 / 100 St.							ohne Kugellager, Kunststoff without ball bearing, plastic

Vorhangrolle für Profil Nr. 100, zum Vernieten

Curtain track roller for profile no. 100, for riveting



NR. no.	VE PU	Breite width	Länge length	↔	*	Ø Rolle Ø roll	Breite Rolle width of roll	Ausführung description
10306	1 / 100 St.	20 mm	70 mm	20 mm	5 mm	22 mm	21 mm	mit Kugellager, Kunststoff with ball bearing, plastic
11410	1 / 100 St.							ohne Kugellager, Kunststoff without ball bearing, plastic

Vorhangrolle, zum Verschrauben

Curtain track roller, for screwing



NR. no.	VE PU	Breite width	Länge length	↔	Ø Rolle Ø roll	Breite Rolle width of roll	Ausführung description
10587	1 / 100 St.	30 mm	85 mm	28 mm	20 mm	19 mm	mit Stahlkugellager, für Profil Nr. 45 with steel ball bearing, for profile No. 45
10437	1 / 100 St.				22 mm	21 mm	mit Stahlkugellager, für Profil Nr. 100 with steel ball bearing, for profile No. 100

Vorhangrolle, zum Vernieten

Curtain track roller, for riveting



NR. no.	VE PU	Breite width	Länge length	↔	Ø Rolle Ø roll	Breite Rolle width of roll	Ausführung description
10588	1 / 100 St.	19 mm	71 mm	20 mm	20 mm	19 mm	mit Stahlkugellager, für Profil Nr. 45 with steel ball bearing, for profile No. 45
10589	1 / 100 St.		73 mm		22 mm	21 mm	mit Stahlkugellager, für Profil Nr. 100 with steel ball bearing, for profile No. 100

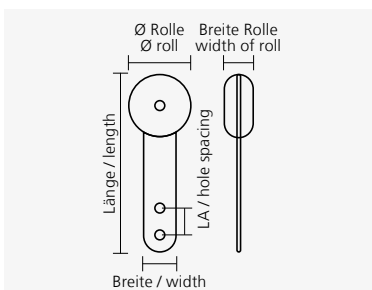

Vorhangrolle für Profil Nr. 100, zum Verschrauben Curtain track roller for profile no. 100, for screwing



NR. no.	VE PU	Breite width	Länge length	↔	Ø Rolle Ø roll	Breite Rolle width of roll	Ausführung description
10824	1 / 50 St.	45 mm	75 mm	28 mm	22 mm	21 mm	mit Stahlkugellager with steel ball bearing

Vorhangdoppelrolle für Profil Nr. 100 Curtain track double roller for profile no. 100



NR. no.	VE PU	Länge length	Ø Rolle Ø roll	Breite Rolle width of roll	Ausführung description
11108	1 St.	65 mm	22 mm	21 mm	mit Stahlkugellager zum Vernieten, 3 Löcher · with steel ball bearing for riveting, 3 holes

Vorhangrolle für Profil Nr. 350 Curtain track roller for profile no. 350



NR. no.	VE PU	Breite width	Länge length	↔	Ø Rolle Ø roll	Breite Rolle width of roll	Ausführung description
11100	1 St.	30 mm	130 mm	42 mm	28 mm	28 mm	mit Stahlkugellager, zum Vernieten with steel ball bearing, for riveting

Vorhangdoppelrolle für Profil Nr. 350 Curtain track double roller for profile no. 350



NR. no.	VE PU	Länge length	↔	Ø Rolle Ø roll	Breite Rolle width of roll	Ausführung description
11101	1 St.	130 mm	42 mm	28 mm	28 mm	mit Stahlkugellager, zum Vernieten · with steel ball bearing, for riveting

Doppelrolle für Profil Nr. 350 Double roller for profile no. 350



NR. no.	VE PU	Breite width	Länge length	Ø Rolle Ø roll	Breite Rolle width of roll	Ausführung description
12386	1 St.	80 mm	84 mm	30 mm	32 mm	mit Stahlkugellager, mit Gewindebolzen zur Montage von Toren · with steel ball bearing, with threaded bolt for mounting gates
12387	1 St.	112 mm	84 mm	30 mm	32 mm	mit Gewindebolzen zur Montage von Toren, mit Haken zur Tor-Arrittierung in Verbindung mit Art. 12388 with threaded bolts for mounting gates, with hooks for gate fixing in conjunction with Art. 12388

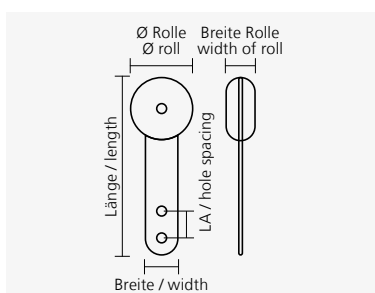

SCHIEBEPLANENSYSTEME · SIDE CURTAIN SYSTEMS

Vorhangdoppelrolle mit Schmalsteg

Curtain track double roller with narrow tongue



NR. no.	VE PU	Länge length	↔	Ø Rolle Ø roll	Breite Rolle width of roll	Ausführung description
11477	1 / 100 St.	71 mm	20 mm	20 mm	19 mm	mit Stahlkugellager zum Vernieten, für Profil Nr. 45 · with steel ball bearing for riveting, for profile No. 45
11478	1 / 100 St.	73 mm	20 mm	22 mm	21 mm	mit Stahlkugellager zum Vernieten, für Profil Nr. 100 · with steel ball bearing for riveting, for profile No. 100

Rollenhalter für Vorhangschiene Nr. 13

Roller holder for curtain rail no. 13



NR. no.	VE PU	Länge length	Ø Rolle Ø roll	Breite Rolle width of roll	Farbe colour	Ausführung description
10431	1 St.	73 mm	15 mm	14 mm	weiß white	mit selbstlochenden Nieten vormontiert preassembled with self-piercing rivets
11519	1 St.	73 mm	15 mm	14 mm	weiß white	mit Schraubkappen und NIROSTA-Schrauben with screw caps and stainless steel screws
12157	1 St.	73 mm	15 mm	14 mm	schwarz black	mit Schraubkappen und NIROSTA-Schrauben with screw caps and stainless steel screws

Rollenhalter für Vorhangschiene Nr. 45

Roller holder for curtain rail no. 45



NR. no.	VE PU	Länge length	Ø Rolle Ø roll	Breite Rolle width of roll	Farbe colour	Ausführung description
10432	1 St.	75 mm	20 mm	19 mm	weiß white	mit selbstlochenden Nieten vormontiert preassembled with self-piercing rivets
11520	1 St.	75 mm	20 mm	19 mm	weiß white	mit Schraubkappen und NIROSTA-Schrauben with screw caps and stainless steel screws

Rollenhalter für Zeltprofile

Roller holder for tent profiles



NR. no.	VE PU	Länge length	Ø Rolle Ø roll	Breite Rolle width of roll	Ausführung description
11508	1 St.	73 mm	14 mm	14 mm	mit Schraubkappen und NIROSTA-Schrauben with screw caps and stainless steel screws

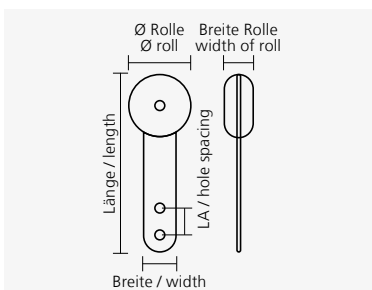

Einschlagclip – super schnelle Montage! Einfach mit Hammer zuclipsen!
Impact clip – super quick assembly! Simply clip with a hammer!



NR. no.	VE PU	Ø	Länge length	Farbe colour	Ausführung, Material description, material
11708	100 St.	11 mm	62 mm	weiß white	mit Kugelkopf, für Profil Nr. 13 und Zeltprofile with ball head, for profile No. 13 and tent profiles
11724	100 St.	7 - 10 mm	62 mm	weiß white	mit Alugleiter für Alukederschienen mit Kedernut, Kunststoff / Aluminium with aluminium roller slider for aluminium keder rails, plastic / aluminium
11710	100 St.		62 mm	weiß white	mit Halbrundring · with half round ring
11707	100 St.		60 mm	weiß white	mit Rollenhalter für Profil Nr. 13 with roller holder for profile No. 13

40 kg Festigkeit pro Clip.
40 kg strength per clip.



Vorhangschiene, Stahl sendzimirverzinkt
Curtain rail, steel sendzimirised



NR. no.	VE PU	Breite width	Höhe height	Länge length	*	Farbe colour	Ausführung, Material description, material
10751	1 / 10 St.	19 mm	19 mm	6 m	1.3 mm		Nr. 13, sendzimirverzinkt No. 13, sendzimir galvanized
12056	1 / 10 St.	19 mm	19 mm		1.3 mm	weiß white	Nr. 13, pulverbeschichtet No. 13, powder coated
12057	1 / 10 St.	19 mm	19 mm		1.3 mm	schwarz black	Nr. 13, pulverbeschichtet No. 13, powder coated
10752	1 / 5 St.	25 mm	24 mm		1.4 mm		Nr. 45, sendzimirverzinkt No. 45, sendzimir galvanized
10753	1 / 5 St.	30 mm	28 mm		1.7 mm		Nr. 100, sendzimirverzinkt No. 100, sendzimir galvanized
11094	1 / 3 St.	40 mm	40 mm		2.5 mm		Nr. 350, sendzimirverzinkt No. 350, sendzimir galvanized

Die Vorhangschiene Nr. 13 wird für den Außenbereich nicht empfohlen.
Profile No. 13 is not recommended for outdoor use.



SCHIEBEPLANENSYSTEME · SIDE CURTAIN SYSTEMS

Kreisbogen, 90° Circular arc, 90°



NR. no.	VE PU	Ausführung, Material description, material
10780	1 St.	für Vorhangschiene Nr. 13, r = 450 mm, Stahl sendzimirverzinkt for curtain rail No. 13, r = 450 mm, steel sendzimir galvanized
10781	1 St.	für Vorhangschiene Nr. 45, r = 650 mm, Stahl sendzimirverzinkt for curtain rail No. 45, r = 650 mm, steel sendzimir galvanized
11411	1 St.	für Vorhangschiene Nr. 100, r = 650 mm, Stahl sendzimirverzinkt for curtain rail No. 100, r = 650 mm, steel sendzimir galvanized

Gestreckte Länge: 2 m.
Extended length: 2 m.

Kreisbogen, 90°, Radius = 500 mm Circular arc, 90°, radius = 500 mm



NR. no.	VE PU	Ausführung, Material description, material
10782	1 St.	für Vorhangschiene Nr. 100, Stahl sendzimirverzinkt for curtain rail No. 100, steel sendzimir galvanized
11095	1 St.	für Vorhangschiene Nr. 350, Stahl sendzimirverzinkt for curtain rail No. 350, steel sendzimir galvanized

Gestreckte Länge: 1,4 m.
Extended length: 1,4 m.

Decken- und Wandbefestigungsmuffe, variabel für Vorhangschiene Nr. 13 Wall or ceiling wall fastening sleeve, variable for curtain rail no. 13



NR. no.	VE PU	Farbe colour	Ausführung, Material description, material
12059	1 St.		verzinkt · zinc plated
12055	1 St.	schwarz · black	pulverbeschichtet · powder coated
12054	1 St.	weiß · white	pulverbeschichtet · powder coated

Wandbefestigungsmuffe, verzinkt Wall mounting sleeve, zinc plated

	NR. no.	VE PU	Ausführung description
	12144	1 St.	für Vorhangschiene Nr. 13 · for curtain rail No. 13
	10787	1 St.	für Vorhangschiene Nr. 45 · for curtain rail No. 45
	10788	1 St.	für Vorhangschiene Nr. 100 · for curtain rail No. 100
	11096	1 St.	für Vorhangschiene Nr. 350 · for curtain rail No. 350
	11959	1 St.	doppelt, für Vorhangschiene Nr. 100 double, for curtain rail No. 100

Deckenbefestigungsmuffe, verzinkt Ceiling mounting sleeve, zinc plated

	NR. no.	VE PU	Ausführung description
	12145	1 St.	für Vorhangschiene Nr. 13 · for curtain rail No. 13
	10790	1 St.	für Vorhangschiene Nr. 45 · for curtain rail No. 45
	10791	1 St.	für Vorhangschiene Nr. 100 · for curtain rail No. 100
	11097	1 St.	für Vorhangschiene Nr. 350 · for curtain rail No. 350
	11958	1 St.	doppelt, für Vorhangschiene Nr. 100 · double, for curtain rail No. 100



SCHIEBEPLANENSYSTEME · SIDE CURTAIN SYSTEMS

Verbindungsuffe, verzinkt Connecting sleeve, zinc plated



NR. no.	VE PU	Ausführung description
10792	1 St.	für Vorhangschiene Nr. 13 · for curtain rail No. 13
10793	1 St.	für Vorhangschiene Nr. 45 · for curtain rail No. 45
10794	1 St.	für Vorhangschiene Nr. 100 · for curtain rail No. 100
11098	1 St.	für Vorhangschiene Nr. 350 · for curtain rail No. 350

Schienen-/ Rollenstopper Rails-/ rollers stop



NR. no.	VE PU	Ausführung description
10783	1 St.	für Vorhangschiene Nr. 13 · for curtain rail No. 13
10784	1 St.	für Vorhangschiene Nr. 45 · for curtain rail No. 45
10785	1 St.	für Vorhangschiene Nr. 100 · for curtain rail No. 100
11099	1 St.	für Vorhangschiene Nr. 350 · for curtain rail No. 350

Stopper für Vorhangschiene Nr. 350 Rails stop for rail no. 350



NR. no.	VE PU	Höhe height	Länge length	Ausführung description
12388	1 St.	40 mm	50 mm	mit Verriegelungsvorrichtung, zur Tor-Arrtierung in Verbindung mit Rolle Art. 12387 with locking device, for door authorisation in conjunction with roller Art. 12387

Gegenplatte Twinfix, mit selbstsichernden Muttern Twinfix counter plate, with self-securing nuts



NR. no.	VE PU	Breite width	Länge length	↔	Ausführung, Material description, material
10142	100 / 500 St.	20 mm	45 mm	28 mm	Schraubenlänge 12 mm, Nirosta · screw length 12 mm, INOX
10617	100 / 500 St.	20 mm	45 mm	28 mm	Schraubenlänge 14 mm, Nirosta · screw length 14 mm, INOX
11769	100 St.	20 mm	45 mm	28 mm	Schraubenlänge 16 mm, Nirosta · screw length 16 mm, INOX
11248	100 St.				lose selbstsichernde Muttern M6, Nirosta loose self-locking nuts M6, INOX

Nirosta-Gegenplatte

Inox counter plate



NR. no.	VE PU	Breite width	Länge length	↔	Ausführung · description
11892	100 St.	20 mm	45 mm	28 mm	Schraubenlänge: 14 mm, M6 Mutter mit Sperrverzahnung, Nirosta · screw length 14 mm, with M6 nut with locking teeth, INOX
11893	100 St.				lose M6 Muttern mit Sperrverzahnung, Nirosta · loose M6 nuts with locking teeth, INOX

Bolzen

Bolts



NR. no.	VE PU	Ausführung, Material description, material	
10955	500 St.	Klemmbereich 3.2 - 6.4 mm, Aluminium	zum Vernieten von Spannern und Rollen for riveting of buckles and rollers
10956	500 St.	clamping area 4.8 - 7.9 mm, Aluminium	
10963	500 St.	Klemmbereich 4.8 - 7.9 mm, Nirosta	

Schliessring

Closing ring



NR. no.	VE PU	Material · material
10957	500 St.	Aluminium · aluminium
10964	500 St.	Nirosta · INOX

Übertotpunktspanner, Nirosta, komplett

Over center buckle, INOX, complete



NR. no.	VE PU	Breite width	Länge length	↔	Ausführung, Material description, material
10203	1 / 30 St.	45 mm	65 cm	28 mm	mit Drahhaken, verzinkt with wire hook, zinc plated
10204	1 / 30 St.	45 mm	65 cm	28 mm	mit NIROSTA-Flachhaken with NIROSTA flat hook
11185	1 / 30 St.	45 mm	65 cm	28 mm	mit NIROSTA-Flachhaken und silbernem Gurtband with INOX flat hook and silver coloured webbing
10208	1 / 30 St.	45 mm		28 mm	NIROSTA-Spanner, einzeln ohne Gurtband INOX-buckle, single without webbing



Übertotpunktspanner, Nirosta, komplett, schwarz pulverbeschichtet Over-centre buckle, INOX, complete, black powder coated

NR. no.	VE PU	Breite width	Länge length	↔	Farbe · colour	Ausführung description
	1 St.	45 mm	65 cm	28 mm	schwarz · black	mit Drahhaken with wire hook
	1 St.	45 mm	65 cm	28 mm	schwarz · black	mit Flachhaken with flat hook

Kippsicherheitsverschluss, Nirosta, komplett Buckle positive lock, INOX, complete

NR. no.	VE PU	Breite width	Länge length	↔	Ausführung description
	1 / 30 St.	45 mm	65 cm	28 mm	mit Drahhaken, verzinkt with wire hook, zinc plated
	1 / 30 St.	45 mm	65 cm	28 mm	mit NIROSTA-Flachhaken with INOX flat hook
	1 / 30 St.	45 mm	85 cm	28 mm	mit NIROSTA-Flachhaken with INOX flat hook
	1 / 30 St.	45 mm	120 cm	28 mm	mit NIROSTA-Flachhaken with INOX flat hook
	1 / 30 St.	45 mm		28 mm	Kippsicherheitsverschluss, einzeln ohne Gurtband Buckle positive lock, „single“ without webbing

Kippsicherheitsverschluss, Nirosta, komplett Buckle positive lock, INOX, complete

NR. no.	VE PU	Breite width	Länge length	↔	Ausführung description
	1 / 30 St.	45 mm	65 cm	28 mm	mit NIROSTA-Flachhaken und Bremse with INOX flat hook and brake
	1 / 30 St.	45 mm	65 cm	28 mm	mit Zink-Nickel Flachhaken (3 Sicken) und Bremse · With zinc-nickel flat hook and brake
	1 / 30 St.	45 mm	65 cm		Kippsicherheitsverschluss mit Bremse, einzeln ohne Gurtband · Buckle posi- tive lock with brake, „single“ without webbing

Ersatzgurtband, Polyester Replacement webbing, Polyester



NR. no.	VE PU	Breite width	Länge length	Farbe colour	Ausführung description
10471	1 St.	45 mm	65 cm	schwarz black	mit Drahhaken, verzinkt with wire hook, zinc plated
10209	1 St.	45 mm	85 cm	schwarz black	mit Drahhaken, verzinkt with wire hook, zinc plated
10472	1 St.	45 mm	65 cm	schwarz black	mit NIROSTA-Flachhaken with INOX flat hook
11580	1 St.	45 mm	65 cm	schwarz black	mit MAXX-NIROSTA-Flachhaken with MAXX-NIROSTA flat hook
11057	1 St.	45 mm	85 cm	schwarz black	mit NIROSTA-Flachhaken with INOX flat hook
11525	1 St.	45 mm	120 cm	schwarz black	mit NIROSTA-Flachhaken with INOX flat hook
11186	1 St.	45 mm	65 cm	silbergrau silver grey	mit NIROSTA-Flachhaken with INOX flat hook
11909	1 St.	45 mm	65 cm	schwarz black	mit Flachhaken Zink-Nickel with flat hook zinc nickel

Ersatzgurtband, Polyester Replacement webbing, polyester



NR. no.	VE PU	Breite width	Länge length	Farbe colour	Ausführung description
12044	1 St.	45 mm	65 cm	schwarz black	mit Drahhaken, schwarz pulverbeschichtet, verzinkt with wire hook, black powder coated, zinc plated
12045	1 St.	45 mm	65 cm	schwarz black	mit Flachhaken, schwarz pulverbeschichtet, Nirosta · with flat hook, black powder coated, INOX
12048	1 St.	45 mm	65 cm	schwarz black	mit Flachhaken mit 2 Sicken, Stahl Zink-Nickel beschichtet, schwarz pulverbeschichtet · with flat hook with 2 beads, steel zinc-nickel coated, black powder coated

Ersatzhaken Replacement hook



NR. no.	VE PU	Breite width	Ausführung, Material description, material
10521	1 St.	45 mm	Drahhaken, verzinkt · wire hook, zinc plated
10522	1 St.	45 mm	Flachhaken, Nirosta · flat hook, INOX
11912	1 St.	45 mm	Flachhaken, Stahl Zink-Nickel beschichtet flat hook, steel zinc-nickel coated



SCHIEBEPLANENSYSTEME · SIDE CURTAIN SYSTEMS

Ersatzhaken Replacement hook



NR. no.	VE PU	Breite width	Farbe · colour	Ausführung, Material description, material
12040	1 St.	45 mm	schwarz · black	Drahthaken, schwarz pulverbeschichtet, verzinkt · wire hook, black powder coated, zinc plated
12047	1 St.	45 mm	schwarz · black	Flachhaken, schwarz pulverbeschichtet, Nirosta · flat hook, black powder coated, INOX
12041	1 St.	45 mm	schwarz · black	Flachhaken mit 2 Sicken, schwarz pulverbeschichtet, Stahl Zink-Nickel beschichtet flat hook with 2 beads, black powder coated, steel zinc-nickel coated

Türstopper, zur Montage an Spannern Door stop, for attachment to buckles



NR. no.	VE PU	Farbe · colour	Ausführung · description
11593	1 St.	grau · grey	Gummi, inkl. NIROSTA-Schraube und Mutter · rubber, incl. INOX-screw and Nut
11594	1 St.		Montage Türstopper an Spanner attachment of door stop to buckles
11883	1 St.	weiß · white	Türpuffer Bumsi, Kunststoff, selbstklebend door buffer „Bumsi“, plastic, self-adhesive

PVC Gurtband zum Verschweissen PVC webbing for welding



NR. no.	VE PU	Breite width	↔	Farbe · colour	
10197	100 lfm	48 mm	1300 kg	weiß · white	
10198	100 lfm		1300 kg	grau · grey	
10199	100 lfm		1300 kg	schwarz · black	
10200	100 lfm		2400 kg	weiß · white	
10201	100 lfm		2400 kg	grau · grey	
10202	100 lfm		2400 kg	schwarz · black	

Zertifiziert für Ladungssicherungsplanen.
Certified for load securing tarpaulins.

Schlaufenband einseitig, mit PVC beschichtet Loop belt coated on one side, with PVC



NR. no.	VE PU	Breite width	↔	Farbe · colour	Ausführung description
11952	100 lfm	50 mm	1000 kg	weiß · white	rückseitig PVC-beschichtet (verschweißbar), mit verwebten Schlaufen ca. 110 mm lang, zur direkten Befestigung von Werbebannern mit Expanderschlingen o. ä. an Gerüsten etc., RF der Schlaufe = 175 kg PVC-coated on the back (weldable), with woven loops approx. 110 mm long, for direct attachment of advertising banners with expander loops or similar to scaffolding etc., breaking force of the loop = 175 kg

Vandalismusschutzstreifen, PVC, mit Stahldrahteinlage, verzinkt Anti-vandalism strip, PVC, with steel wire insert, zinc plated



NR. no.	VE PU	Breite width	Farbe · colour	
11848	150 lfm	2.5 cm	transparent	

Gurtband Polyester (UV-Beständig) Polyester webbing (UV-proof)



NR. no.	VE PU	Breite width	↔	Farbe · colour	Ausführung description
10416	100 lfm	45 mm	3000 daN	schwarz · black	für Spanner for buckles

Alurundprofil, Ø 34 mm Aluminium round profile, Ø 34 mm



NR. no.	VE PU	Ø	Länge length	Ausführung, Material description, material
11335	1 St.	34 mm	3 m	für Keder Ø 13 mm, Alu blank for keder Ø 13 mm, aluminium bare
11225	1 St.	34 mm	3.30 m	für Keder Ø 13 mm, Alu blank for keder Ø 13 mm, aluminium bare
11360	1 St.	34 mm	6 m	für Keder Ø 13 mm, Alu blank for keder Ø 13 mm, aluminium bare
11576	1 St.	34 mm	3 m	mit fest montiertem Messingadapter, mit Schlitzaufnahme, Alu blank with firmly fitted brass adapter, with slot attachment, aluminium bare
11577	1 St.	34 mm	3.3 m	mit fest montiertem Messingadapter, mit Schlitzaufnahme, Alu blank with firmly fitted brass adapter, with slot attachment, aluminium bare



Alurundprofil, Ø 27 mm

Aluminium round profile, Ø 27 mm

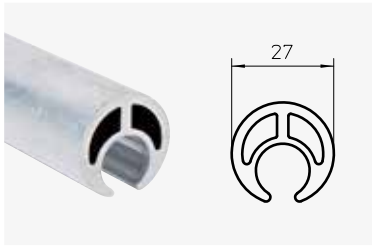

NR. no.	VE PU	Ø	Länge length	Ausführung, Material description, material
11460	1 St.	27 mm	2.70 m	für Keder Ø 13 mm, Alu blank for keder Ø 13 mm, aluminium bare
11334	1 St.	27 mm	3 m	für Keder Ø 13 mm, Alu blank for keder Ø 13 mm, aluminium bare
10310	1 St.	27 mm	3.30 m	für Keder Ø 13 mm, Alu blank for keder Ø 13 mm, aluminium bare

Alurundprofil, Ø 27 mm

Aluminium round profile, Ø 27 mm



NR. no.	VE PU	Ø	Länge length	Ausführung, Material description, material
11546	1 St.	27 mm	3 m	mit Vierkantaufnahme 12 x 12 mm, Alu blank with female square attachment 12 x 12 mm, aluminium bare
11547	1 St.	27 mm	3.30 m	mit Vierkantaufnahme 12 x 12 mm, Alu blank with female square attachment 12 x 12 mm, aluminium bare
11313	1 St.	10 mm	20 mm	Feststellschraube für Sidecurtainprofile locking screw for side curtain profiles
11245	1 St.	12 mm	16 mm	Feststellschraube für Sidecurtainprofile locking screw for side curtain profiles

Alueinhakprofil Typ ST

Aluminium catch rail type ST

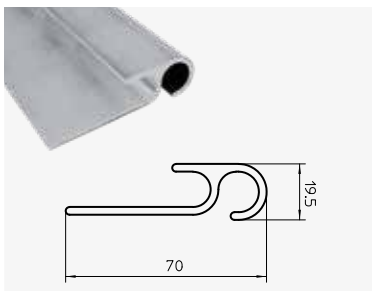

NR. no.	VE PU	Breite width	Höhe height	Länge length	Ausführung, Material description, material
11305	1 St.	19.5 mm	70 mm	3 m	für Keder Ø 13 mm, Alu blank for keder Ø 13 mm, aluminium bare
11336	1 St.	19.5 mm	70 mm	3.30 m	für Keder Ø 13 mm, Alu blank for keder Ø 13 mm, aluminium bare

Alueinhakprofil Typ AE

Aluminium catch rail type AE

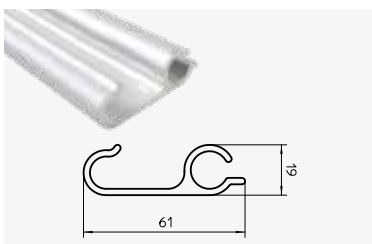

NR. no.	VE PU	Breite width	Höhe height	Länge length	Ausführung, Material description, material
11545	1 St.	19 mm	61 mm	3 m	für Keder Ø 13 mm, Alu blank for keder Ø 13 mm, aluminium bare
11549	1 St.	19 mm	61 mm	3.30 m	für Keder Ø 13 mm, Alu blank for keder Ø 13 mm, aluminium bare

Passende Handgriffe, siehe Seite 175.
Matching handles, please see page 175.

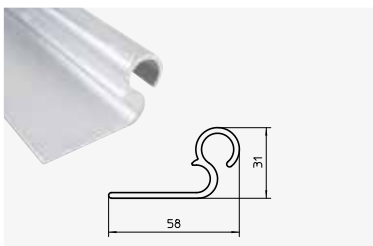
Alueinhakprofil Typ Uni
 Aluminium catch rail type uni

NR. no.	VE PU	Breite width	Höhe height	Länge length	Ausführung, Material description, material
11337	1 St.	31 mm	58 mm	3.30 m	für Keder Ø 13 mm, Alu blank for keder Ø 13 mm, aluminium bare

Adapter „Unten“
 Adapter "lower part"

NR. no.	VE PU	Ausführung, Material description, material
11612	1 St.	für Rundprofil Ø 27 mm, mit Vierkantaufnahme 12 x 12 mm, Messing · for round profile Ø 27 mm, with female square attachment 12 x 12 mm, brass
12155	1 St.	für Rundprofil Ø 27 mm, mit Schlitzaufnahme, Aluminium geschmiedet · for round profile Ø 27 mm, with slot attachment, aluminium forged
11227	1 St.	für Rundprofil Ø 34 mm, mit Schlitzaufnahme, Messing for round profile Ø 34 mm, with slot attachment, brass
11374	1 St.	für Rundprofil Ø 34 mm, mit Vierkantaufnahme 12 x 12 mm, Messing · for round profile Ø 34 mm, with female square attachment 12 x 12 mm, brass

Adapter „Oben“
 Adapter "upper part"

NR. no.	VE PU	Ausführung, Material description, material
10311	1 St.	für Rundprofil Ø 27 mm, Messing for round profile Ø 27 mm, brass
11226	1 St.	für Rundprofil Ø 34 mm, Messing for round profile Ø 34 mm, brass

Haltewinkel, Stahl verzinkt
 Retaining bracket, steel zinc plated

NR. no.	VE PU	Ausführung description
11599	1 St.	für Alurundprofile Ø 27 mm for round profiles Ø 27 mm
11608	1 St.	für Alurundprofile Ø 34 mm for round profiles Ø 34 mm



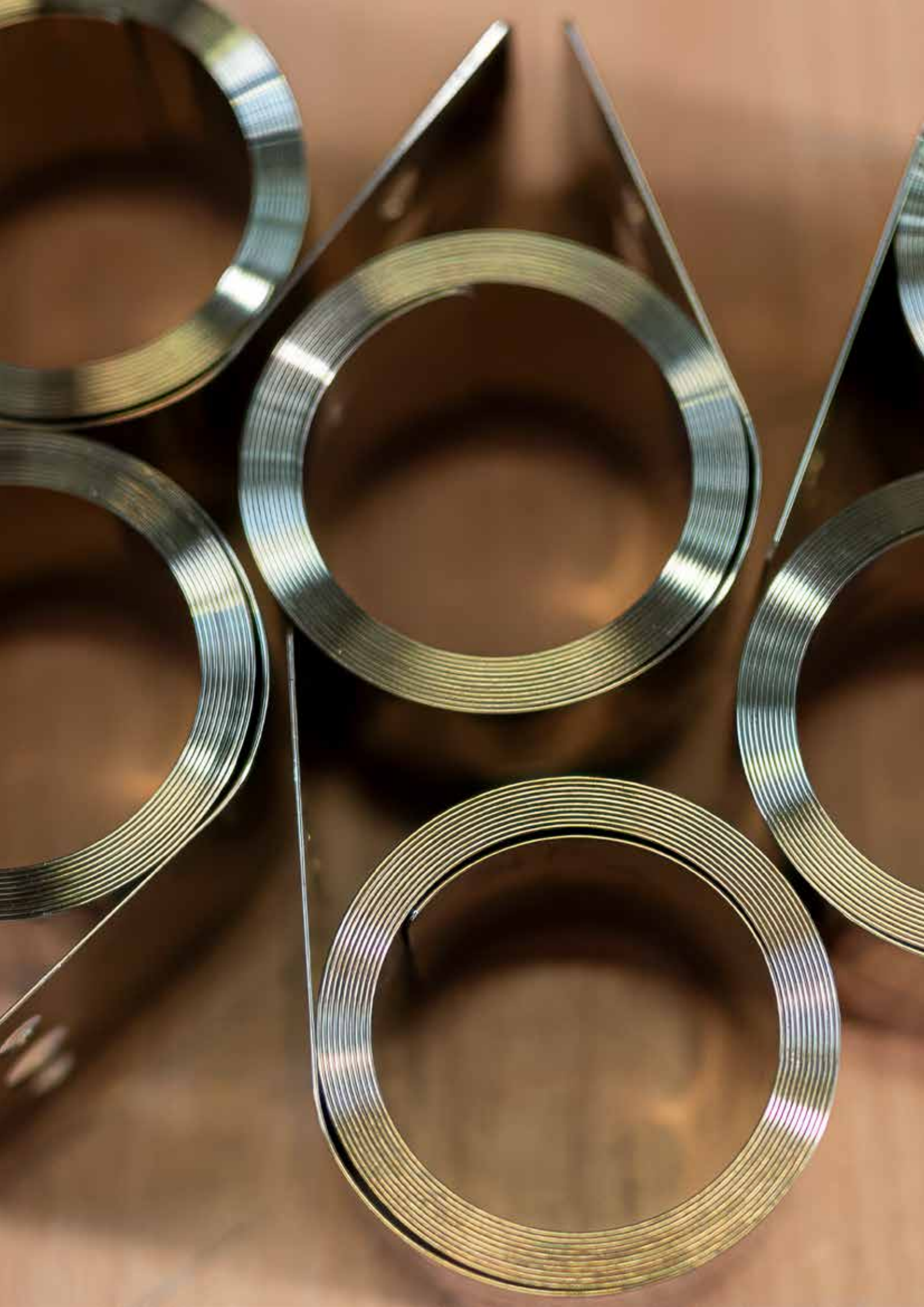



**PLANEN-
AUFROLLSYSTEME
ROLL-UP SYSTEMS
FOR TARPAULINS**



Horizontalspanner, Kurbelausführung Horizontal tensioner, crank design



NR. no.	VE PU	Breite width	Höhe height	Länge length	Ausführung · description
11730	1 St.	50 mm	45 mm	120 mm	Kurbelausführung, Übersetzung 16:1, mit Schlitzaufnahme, inkl. Kurbel crank version, transmission 16:1, with slot attachment, incl. crank
11731	1 St.	50 mm	45 mm	120 mm	Kurbelausführung, Übersetzung 16:1, mit Vierkantaufnahme, inkl. Kurbel crank version, transmission 16:1, with female square attachment, incl. crank
11732	1 St.	50 mm	45 mm	120 mm	Handradausführung, Übersetzung 16:1, mit Schlitzaufnahme handwheel design, transmission 16:1, with slot attachment
11733	1 St.	50 mm	45 mm	120 mm	Handradausführung, Übersetzung 16:1, mit Vierkantaufnahme handwheel design, transmission 16:1, with female square attachment
11734	1 St.	34 mm	48 mm	120 mm	Ratschenspannung, mit Vierkantaufnahme · ratchet tensioning, with female square attachment
11735	1 St.	41 mm	48 mm	120 mm	Ratschenspannung, mit Schlitzaufnahme · ratchet tensioning, with slot attachment

Beidseitig verwendbar.
Usable on both sides.

Horizontalspanner, Stahl verzinkt Horizontal tensioner, steel zinc plated



NR. no.	VE PU	Breite width	Höhe height	Länge length	Ausführung · description
11405	1 St.	40 mm	80 mm	270 mm	mit Sperre, links vorne, rechts hinten with lock, left front, right rear
11406	1 St.	40 mm	80 mm	270 mm	mit Sperre, rechts vorne, links hinten with lock, right front, left rear

Alukederschiene Aluminium keder rail

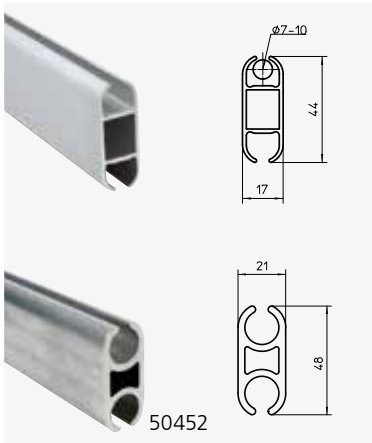

NR. no.	VE PU	Breite width	Höhe height	Länge length	Farbe colour	Ausführung · description
50064	1 / 12 St.	17 mm	44 mm	2.55 m		Alu blank · aluminium bare
50062	1 / 12 St.	17 mm	44 mm	6.05 m		Alu blank · aluminium bare
50065	1 / 12 St.	17 mm	44 mm	2.55 m		Alu eloxiert aluminium anodised
50008	1 / 12 St.	17 mm	44 mm	3.50 m		Alu eloxiert aluminium anodised
50015	1 / 12 St.	17 mm	44 mm	6.05 m		Alu eloxiert aluminium anodised
50259	1 / 12 St.	17 mm	44 mm	6.05 m	weiß white	Alu pulverbeschichtet aluminium powder-coated
50258	1 / 12 St.	17 mm	44 mm	6.05 m	schwarz black	Alu pulverbeschichtet aluminium powder-coated
50452	1 / 12 St.	21 mm	48 mm	6.05 m		Alu blank · aluminium bare

Verbindungsachse für Alukederprofile
Connectors for aluminium keder rails

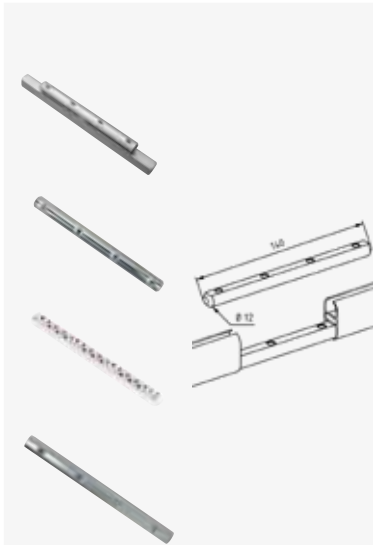

Nr. no.	VE PU	Ø	Länge length	Ausführung, Material description, material
50001	1 / 10 St.	11 mm	140 mm	für Alukederschiene 17 x 44 mm, mit Verdrehsschutz, Stahl verzinkt for aluminium keder rails 17 x 44 mm with anti-twist safeguard, steel zinc plated
50004	1 / 10 St.	12 mm	140 mm	inkl. Gewindestiften, Stahl verzinkt incl. grub screws, steel zinc plated
50742	1 / 10 St.	12 mm	140 mm	inkl. Gewindestiften (verzinkt), Kunststoff Polyamid 6 incl. grub screws (galvanised), plastic polyamide 6
50471	1 / 10 St.	12 mm	140 mm	inkl. Gewindestiften, passend für Alukederschiene Art. 50452, Stahl verzinkt incl. grub screws, fits for aluminium channel rail art. 50452, steel zinc plated

Komponente für Rollfixsysteme
Component for rollfix systems



NR. no.	VE PU	Breite width	Höhe height	Ausführung, Material description, material
11206	1 St.	13 mm	16 mm	Schiebevierkant, Stahl verzinkt sliding female square, steel zinc plated
11307	1 St.			Feststellschraube für Schiebevierkant, Alu/Stahl locking screw for sliding female square, aluminium/steel

Aluminiumwickelrohrprofil
Aluminium winding tube profile

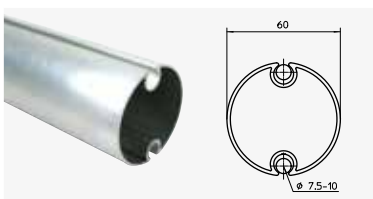

Nr. no.	VE PU	Ø	Länge length	Ausführung, Material description, material
11859	1 / 10 St.	60 mm	6.00 m	mit 2 Kedernuten, Alu blank with 2 keder grooves, aluminium bare

Teleskopkurbel
Telescopic crank



Nr. no.	VE PU	Länge length	Ausführung description
11633	1 St.	1.6 - 2.4 m	Übersetzung 7:1 transmission 7:1



Rollfixkurbel, starre Ausführung

Rollfix crank, rigid execution



NR. no.	VE PU	Länge length	Ausführung · description
12160	1 St.	1.30 m	Übersetzung 3:1 · transmission 3:1
11784	1 St.	1.30 m	Übersetzung 7:1 · transmission 7:1
11521	1 St.	1.50 m	Übersetzung 7:1 · transmission 7:1
11482	1 St.	2.30 m	Übersetzung 7:1 · transmission 7:1
11489	1 St.	2.30 m	Übersetzung 13:1 · transmission 13:1
12163	1 St.		Kurbel Aufnahme mit Vierkant 18 x 18 mm, passend zum Adapterstück Art. 12164 · Crank holder with square 18 x 18 mm, suitable for adapter piece Art. 12164
12164	1 St.		Adapterstück (Kunststoff POM Natur) passend für Wickelrohrprofil Ø 60 mm, mit Innenvierkant für 18 x 18 mm, passend zu Artikel 12163 · Adapter piece (plastic POM nature) suitable for winding tube profile Ø 60 mm, with internal square for 18 x 18 mm, suitable for article 12163

Klappbare Kurbel für Aufrollsysteme

Foldable crank for roll-up systems



NR. no.	VE PU	Länge length	Ausführung · description
11998	1 St.	2.40 m	Übersetzung 7:1 · transmission 7:1
11999	1 St.	2.70 m	Übersetzung 7:1 · transmission 7:1
12000	1 St.	3.10 m	Übersetzung 7:1 · transmission 7:1
12001	1 St.	2.40 m	Übersetzung 13:1 · transmission 13:1
12002	1 St.	2.70 m	Übersetzung 13:1 · transmission 13:1
12003	1 St.	3.10 m	Übersetzung 13:1 · transmission 13:1

Ersatzgetriebe für Rollfixkurbeln

Replacement gearbox for rollfix crank



NR. no.	VE PU	Ausführung · description
11490	1 St.	Übersetzung 7:1 · transmission 7:1
11491	1 St.	Übersetzung 13:1 · transmission 13:1

Federn

Rollup spring



NR. no.	VE PU	Breite width	Länge length	Material · material
11050	1 St.	40 mm	0.6 m	Nirosta · INOX
11052	1 St.	40 mm	1.1 m	Nirosta · INOX
11053	1 St.	40 mm	1.5 m	Nirosta · INOX
11054	1 St.	40 mm	2 m	Nirosta · INOX
11055	1 St.	40 mm	2.3 m	Nirosta · INOX

Für Planenaufrollsystem.
For roller systems for tarpaulins.

Hilfsmittel zum Montieren der Feder

Tool for spring mounting



NR. no.	VE PU	Länge length	Ausführung · description
11522	1 St.	1.30 m	Montageschiene · mounting bar
11523	1 St.	2 m	Montageschiene · mounting bar
11524	1 St.		Handgriff · hand grip

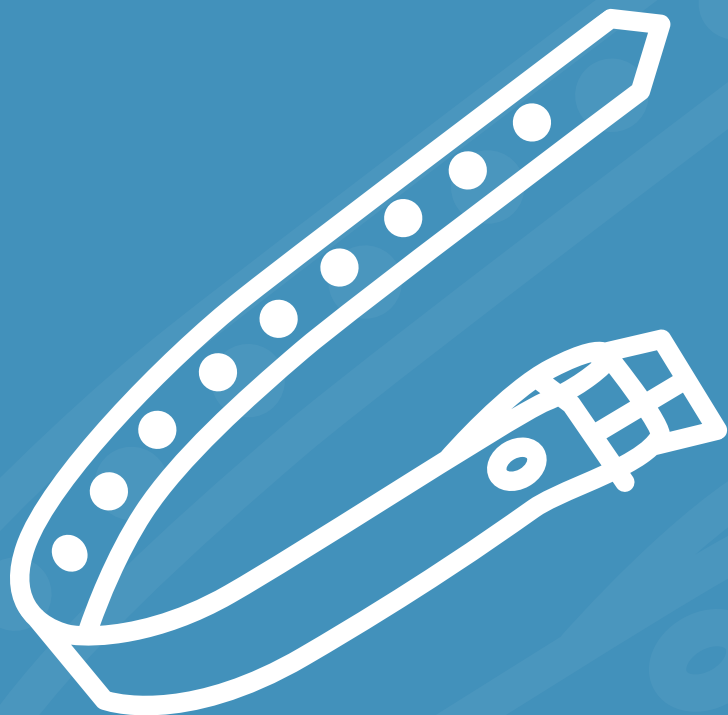

BERIEMUNG STRAPPING



Schnallriemen, aus Kunststoff Buckle strap, plastic



NR. no.	VE PU	Breite width	Länge length	*	Farbe · colour
10006	100 St.	20 mm	200 mm	2.1 mm	beige · beige
10009	100 St.	20 mm	250 mm	2.1 mm	beige · beige
10010	100 St.	20 mm	300 mm	2.1 mm	beige · beige
10011	100 St.	20 mm	350 mm	2.1 mm	beige · beige
10012	100 St.	20 mm	400 mm	2.1 mm	beige · beige
10014	100 St.	20 mm	500 mm	2.1 mm	beige · beige
10016	100 St.	20 mm	600 mm	2.1 mm	beige · beige
10017	100 St.	20 mm	700 mm	2.1 mm	beige · beige
11276	100 St.	20 mm	800 mm	2.1 mm	beige · beige
10019	100 St.	20 mm	900 mm	2.1 mm	beige · beige
10020	100 St.	20 mm	1000 mm	2.1 mm	beige · beige
11229	100 St.	20 mm	1200 mm	2.1 mm	beige · beige
12312	100 St.	25 mm	800 mm	2.1 mm	beige · beige
10076	100 St.	20 mm	250 mm	2.1 mm	weiß · white
10078	100 St.	20 mm	300 mm	2.1 mm	weiß · white
10090	100 St.	20 mm	350 mm	2.1 mm	weiß · white
10092	100 St.	20 mm	500 mm	2.1 mm	weiß · white
10094	100 St.	20 mm	600 mm	2.1 mm	weiß · white
10389	100 St.	20 mm	700 mm	2.1 mm	weiß · white
10018	100 St.	20 mm	800 mm	2.1 mm	weiß · white
10906	100 St.	20 mm	1000 mm	2,1 mm	weiß · white
11884	100 St.	15 mm	200 mm	2.1 mm	schwarz · black
11658	100 St.	15 mm	475 mm	2.1 mm	schwarz · black
11894	100 St.	20 mm	200 mm	2.1 mm	schwarz · black
11969	100 St.	20 mm	250 mm	2.1 mm	schwarz · black
11885	100 St.	20 mm	300 mm	2.1 mm	schwarz · black
11886	100 St.	20 mm	400 mm	2.1 mm	schwarz · black
11970	100 St.	20 mm	530 mm	2.1 mm	schwarz · black

Schnallriemen für Schiebeverdecke Buckle strap for sliding roofs



NR. no.	VE PU	Breite width	Länge length	*	Farbe · colour
10022	100 / 1000 St.	20 mm	230 mm	1.5 mm	weiß · white
10023	100 / 1000 St.	20 mm	230 mm	1.5 mm	schwarz · black

Einschweissplatte PVC
 Punched PVC for welding



NR. no.	VE PU	Breite width	Länge length	Ausführung · description
10900	100 St.	60 mm	60 mm	fertig montiert mit Schnallriemen (Art. 10022) ready mounted with buckle strap (No. 10022)
10546	100 St.	100 mm	100 mm	fertig montiert mit Schnallriemen (Art. 10022) ready mounted with buckle strap (No. 10022)

Einschweissplatte PVC
 Punched PVC for welding

NR. no.	VE PU	Breite width	Länge length	*	Farbe colour	Material · material
10030	100 St.	60 mm	60 mm	0.7 mm	weiß white	PANAMA-Material PANAMA-material
12049	100 St.	60 mm	60 mm	0.7 mm	schwarz black	PANAMA-Material PANAMA-material
10031	100 St.	70 mm	70 mm	0.7 mm	weiß white	PANAMA-Material PANAMA-material
10032	100 St.	80 mm	80 mm	0.7 mm	weiß white	PANAMA-Material PANAMA-material
10034	100 St.	100 mm	100 mm	0.7 mm	weiß white	PANAMA-Material PANAMA-material
10025	100 St.	60 mm	60 mm	2.1 mm	beige beige	Riemenmaterial strap material
10028	100 St.	90 mm	110 mm	2.1 mm	weiß white	Riemenmaterial strap material
10029	100 St.	100 mm	100 mm	2.1 mm	beige beige	Riemenmaterial strap material

Haltestreifen, PVC Panama, für Schiebeverdecke
 Holding strap, PVC panama, for sliding roofs

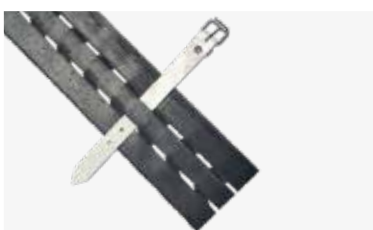
NR. no.	VE PU	Breite width	↔	Farbe colour	Ausführung · description
10722	60 lfm	10 cm	93.5 cm	weiß · white	durchgelocht · punched
11316	60 lfm	10 cm	93.5 cm	schwarz · black	durchgelocht · punched
10719	60 lfm	10 cm	52 cm	weiß · white	durchgelocht · punched

Haltestreifen, aus PVC beschichtetem Gurtband
 Holding strap, made of PVC coated webbing

NR. no.	VE PU	Breite width	↔	Farbe colour	Ausführung · description
12124	60 lfm	98 mm	ca. 20 mm	grau · grey	Geeignet für Heißluft- und Hochfrequenzmaschinen, Laschenabstand: ca. 20 mm Suitable for hot-air and high-frequency machines, tab spacing: approx. 20 mm



Haltestreifen PVC Holding strap PVC



NR. no.	VE PU	Breite width	↔	↔↔	Farbe · colour	Ausführung description
11548	50 lfm	10 cm	1300 kg	93.5 cm	weiß · white	mit aufgeschweißten Einschweißplatten aus PVC with welded welding plates, made of PVC webbing

Strippe, Kunststoff Strap, plastic



NR. no.	VE PU	Breite width	Länge length	↔↔	*	Farbe colour	Ausführung description
10143	100 St.	20 mm	150 mm	20 mm	2.1 mm	beige beige	
10146	100 St.	20 mm	175 mm	20 mm	2.1 mm	beige beige	
10147	100 St.	20 mm	190 mm	20 mm	2.1 mm	beige beige	
10677	100 St.	20 mm	250 mm	20 mm	2.1 mm	beige beige	durchgelocht punched
10920	100 St.	20 mm	500 mm	20 mm	2.1 mm	beige beige	
10155	100 St.	25 mm	190 mm	25 mm	2.1 mm	beige beige	
11962	100 St.	20 mm	190 mm	20 mm	2.1 mm	schwarz black	

Strippe, Kunststoff Strap, plastic



NR. no.	VE PU	Breite width	Länge length	↔↔	*	Farbe · colour
10144	100 St.	20 mm	150 mm	20 mm	2.1 mm	weiß · white
10145	100 St.	20 mm	175 mm	20 mm	2.1 mm	weiß · white
10148	100 St.	20 mm	190 mm	20 mm	2.1 mm	weiß · white
10803	100 St.	20 mm	250 mm	20 mm	2.1 mm	weiß · white
10156	100 St.	25 mm	190 mm	25 mm	2.1 mm	weiß · white

Schnallkappe, Kunststoff, ohne Unterlage Buckle cap, plastic, without protective back plate



NR. no.	VE PU	Breite width	↔↔	*	Farbe · colour
10036	100 St.	20 mm	20 mm	2.1 mm	beige · beige
10519	100 St.	25 mm	25 mm	2.1 mm	beige · beige
10096	100 St.	20 mm	20 mm	2.1 mm	weiß · white
10413	100 St.	25 mm	25 mm	2.1 mm	weiß · white

Passende Nietunterlagen finden Sie auf Seite 120.
Matching washer, see page 120.

Schnallkappe, Kunststoff, mit Unterlage

Buckle cap, plastic, with protective back plate



NR. no.	VE PU	Breite width	↔	*	Farbe · colour	Ausführung description
10039	100 St.	20 mm	20 mm	2.1 mm	beige · beige	mit Schutz with protection
10590	100 St.	25 mm	25 mm	2.1 mm	beige · beige	mit Schutz with protection
10111	100 St.	20 mm	20 mm	2.1 mm	weiß · white	mit Schutz with protection
10115	100 St.	25 mm	25 mm	2.1 mm	weiß · white	mit Schutz with protection
11963	100 St.	20 mm	20 mm	2.1 mm	schwarz · black	mit Schutz with protection

Passende Nietunterlagen finden Sie auf Seite 120.
Matching washer, see page 120.

VW-Stecker

VW-strap



NR. no.	VE PU	*	Farbe colour	Ausführung · description
10046	100 St.	2.1 mm	beige beige	für Ovalösen 27 x 8 mm mit Ausbuchtung for oval eyelets 27 x 8 mm with bulge
10131	100 St.	2.1 mm	schwarz black	für Ovalösen 27 x 8 mm mit Ausbuchtung for oval eyelets 27 x 8 mm with bulge
10047	100 St.	2.1 mm	transluzent translucent	für Ovalösen 27 x 8 mm mit Ausbuchtung for oval eyelets 27 x 8 mm with bulge
11363	100 St.	2.1 mm	oliv olive	für Ovalösen 27 x 8 mm for oval eyelets 27 x 8 mm

Steckstripe

Insertion strap



NR. no.	VE PU	*	Farbe colour	Ausführung · description
10044	100 St.	2.1 mm	beige beige	für Ovalösen 42 x 22 mm for oval eyelets 42 x 22 mm

Steckstripe, Kunststoff

Insertion strap, plastic



NR. no.	VE PU	Breite width	Länge length	*	Farbe colour	
10779	100 St.	25 mm	150 mm	2.1 mm	beige beige	

Mit einem Nietloch.
With one rivet hole.

Handgriff aus Riemenmaterial

Hand grip made from strap material



NR. no.	VE PU	Breite width	Länge length	↔	Farbe colour	Ausführung · description
11979	1 St.	25 mm	285 mm	28 mm	schwarz black	zum Vernieten, aus Riemenmaterial for riveting, from belt material
12423	1 St.	25 mm	350 mm	28 mm	beige beige	zum Vernieten, aus Riemenmaterial for riveting, from belt material



Endriemen, aus Kunststoff End-strap, made of plastic



NR. no.	VE PU	Breite width	↔	*	Farbe · colour	
12412	100 St.	20 mm	20 mm	2.1 mm	weiß · white	
10266	100 St.	20 mm	20 mm	2.1 mm	beige · beige	
11317	100 St.	20 mm	20 mm	2.1 mm	oliv · olive	

Aufrollriemen, aus Kunststoff Roll-up strap, made of plastic



NR. no.	VE PU	Breite width	Länge length	↔	*	Farbe colour	Ausführung description
10048	100 St.	20 mm	300 mm	20 mm	2.1 mm	beige beige	
10050	100 St.	20 mm	400 mm	20 mm	2.1 mm	beige beige	
10052	100 St.	20 mm	500 mm	20 mm	2.1 mm	beige beige	
10159	100 St.	20 mm	300 mm	20 mm	2.1 mm	weiß white	
10160	100 St.	20 mm	400 mm	20 mm	2.1 mm	weiß white	
10161	100 St.	20 mm	500 mm	20 mm	2.1 mm	weiß white	
11318	100 St.	20 mm	400 mm	20 mm	2.1 mm	oliv olive	
11956	100 St.	20 mm	400 mm	20 mm	2.1 mm	schwarz black	mit verzinktem Metallbeschlag with galvanised metal fitting

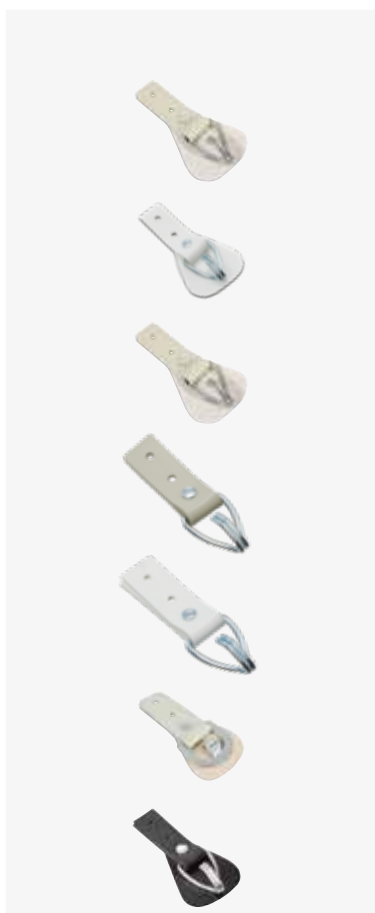

Aufrollsatz
 Roll-up end-strap

NR. no.	VE PU	Breite width	↔	Farbe · colour	Ausführung description
10056	100 St.	20 mm	20 mm	beige · beige	mit Schutz und verzinktem Drahhaken · with protection and zinc plated wire hook
10593	100 St.	20 mm	20 mm	weiß · white	mit Schutz und verzinktem Drahhaken · with protection and zinc plated wire hook
10055	100 St.	25 mm	20 mm	beige · beige	mit Schutz und verzinktem Drahhaken · with protection and zinc plated wire hook
10054	100 St.	20 mm	20 mm	beige · beige	ohne Schutz, mit verzinktem Drahhaken · without protection, with zinc plated wire hook
10003	100 St.	20 mm	20 mm	weiß · white	ohne Schutz, mit verzinktem Drahhaken · without protection, with zinc plated wire hook
10057	100 St.	25 mm	20 mm	beige · beige	mit Schutz und verzinktem Flachhaken · with guard and zinc plated flat hook
11957	100 St.	20 mm	20 mm	schwarz · black	mit Schutz und verzinktem Drahhaken · with protection and zinc plated wire hook

Zollverschlussriemen
 Tir strap

NR. no.	VE PU	Breite width	*	Farbe · colour
10852	50 lfm	15 mm	3 mm	transluzent · translucent
10074	50 lfm	20 mm	3 mm	transluzent · translucent
10079	50 lfm	22 mm	3 mm	transluzent · translucent
10081	50 lfm	24 mm	3 mm	transluzent · translucent

Riemenmaterial
 Strap material

NR. no.	VE PU	Breite width	*	Farbe · colour
10721	50 lfm	20 mm	2.1 mm	beige · beige
10720	50 lfm	24 mm	2.1 mm	beige · beige
12129	50 lfm	20 mm	2.1 mm	oliv · olive
11329	50 lfm	24 mm	2.1 mm	oliv · olive
11552	50 lfm	24 mm	2.1 mm	schwarz · black







WERKZEUGE & MASCHINEN TOOLS & MACHINERY



Rundlocheisen
Hollow punch, round



NR. no.	VE PU	Ø	
10349	1 St.	3 mm	
10350	1 St.	4 mm	
10351	1 St.	5 mm	
10352	1 St.	6 mm	
10353	1 St.	7 mm	
10354	1 St.	8 mm	
10355	1 St.	9 mm	
10356	1 St.	10 mm	
10357	1 St.	12 mm	
10358	1 St.	14 mm	
10359	1 St.	16 mm	
10360	1 St.	18 mm	
10361	1 St.	20 mm	
10362	1 St.	25 mm	
10363	1 St.	36 mm	
10364	1 St.	40 mm	

Ovallocheisen
Hollow punch oval



NR. no.	VE PU	Länge length	Breite width	Ausführung description
10365	1 St.	17 mm	11 mm	
10367	1 St.	27 mm	8 mm	eckig · angular
10368	1 St.	38 mm	8 mm	eckig · angular
11237	1 St.	27 mm	7 mm	
10366	1 St.	22.5 mm	13.5 mm	
10369	1 St.	40 mm	10 mm	
10370	1 St.	42 mm	22 mm	

Doppellocheisen
Double hollow punch



NR. no.	VE PU	Ø	↔	
10742	1 St.	4 mm	20 mm	
10743	1 St.	4 mm	25 mm	
10750	1 St.	6 mm	28 mm	
10749	1 St.	4 mm	30.5 mm	
10747	1 St.	4 mm	34 mm	
10744	1 St.	4 mm	51 mm	

Ersatzlocheisen für Doppellocheisen

Replacement hollow punch for double hollow punch



NR. no.	VE PU	Ø	
10854	1 St.	3 mm	
10855	1 St.	4 mm	
10857	1 St.	6 mm	

Einschlagstempel zum Einsetzen von Rundösen (DIN 7332)

Dies for insertion of round eyelets (DIN 7332)



NR. no.	VE PU	Ø	
10371	1 St.	8 mm	
10372	1 St.	10 mm	
10373	1 St.	12 mm	
10374	1 St.	14 mm	
10375	1 St.	16 mm	
10376	1 St.	18 mm	
10377	1 St.	20 mm	
10378	1 St.	25 mm	
10379	1 St.	36 mm	
10380	1 St.	40 mm	

Durch flachen Kegel und zylindrischen Schaft sehr leichtes Öseneinsetzen und kein Verkleben möglich.
Thanks to the flat cone and the cylindrical shank eyelet installation is very easy and no jamming will occur.

Einschlagstempel zum Einsetzen von einteiligen Zackenösen

Dies for insertion of toothed one-piece eyelets



NR. no.	VE PU	Ø	
11350	1 St.	10 mm	
11965	1 St.	12 mm	
11351	1 St.	16 mm	
11966	1 St.	18 mm	
11352	1 St.	40 mm	

Einschlagstempel zum Einsetzen von Ovalösen (DIN 7332)

Dies for insertion of oval eyelets (DIN 7332)



NR. no.	VE PU	Länge length	Breite width	Ausführung description
10381	1 St.	17 mm	11 mm	
10383	1 St.	27 mm	8 mm	eckig · angular
10386	1 St.	38 mm	8 mm	eckig · angular
10387	1 St.	27 mm	7 mm	
10382	1 St.	22.5 mm	13.5 mm	
10384	1 St.	40 mm	10 mm	
10385	1 St.	42 mm	22 mm	

Durch flachen Kegel und zylindrischen Schaft sehr leichtes Öseneinsetzen und kein Verkleben möglich.
Thanks to the flat cone and the cylindrical shank eyelet installation is very easy and no jamming will occur.



Selbstlochende Einschlagvorrichtung zum Einsetzen von Rundösen DIN
 Self-piercing dies for insertion of round eyelets DIN



NR. no.	VE PU	Ø	Breite width	Höhe height	Länge length	Ausführung, Material description, material
11861	1 St.	8 mm	6 cm	10 cm	15 cm	nur für NIROSTA Öse only for INOX eyelets
11815	1 St.	10 mm	6 cm	10 cm	15 cm	
11823	1 St.	12 mm	6 cm	10 cm	15 cm	
11824	1 St.	14 mm	6 cm	10 cm	15 cm	
11825	1 St.	16 mm	6 cm	10 cm	15 cm	

Ohne Vorlochen der PVC-Plane, durch ein Spezialwerkzeug schneidet die DIN-Öse den Stoff und wird mittels Hammer leicht eingesetzt.

No pre-punching of the PVC tarpaulin is required, thanks to a special tool, the DIN eyelet cuts the fabric and is easily inserted with a hammer.

Einschlagvorrichtung für Seilendverschlüsse
 Wrapping device for cable end clamp



NR. no.	VE PU	Breite width	Höhe height	Länge length	Ausführung description	Videoanleitung instruction video
12393	1 St.	6 cm	10 cm	15 cm	zum Verpressen von Seilendverschlüssen Ø 6 - 10 mm for crimping cable end clamps Ø 6 - 10 mm	

Werkzeugsatz (2-tlg.) für selbstlochende Einschlagvorrichtung
 Tool kit (2-pcs.) for self-piercing dies



NR. no.	VE PU	Ausführung description
11862	1 St.	für DIN Rundösen Ø 8 mm (nur für NIROSTA Öse) for DIN round eyelets Ø 8 mm (only for INOX eyelets)
11826	1 St.	für DIN Rundösen Ø 10 mm · for DIN round eyelets Ø 10 mm
11827	1 St.	für DIN Rundösen Ø 12 mm · for DIN round eyelets Ø 12 mm
11828	1 St.	für DIN Rundösen Ø 14 mm · for DIN round eyelets Ø 14 mm
11829	1 St.	für DIN Rundösen Ø 16 mm · for DIN round eyelets Ø 16 mm
11838	1 St.	zum Verpressen von Seilendverschlüssen Ø 6 - 10 mm for crimping cable end clamps Ø 6 - 10 mm

Werkzeugunterteil (Ersatz) für selbstlochende Einschlagvorrichtung
Tool lower part (replacement) for self-piercing dies



NR. no.	VE PU	Ø	
11863	1 St.	8 mm	
11830	1 St.	10 mm	
11831	1 St.	12 mm	
11832	1 St.	14 mm	
11833	1 St.	16 mm	

Hart-PVC Lochungsunterlage
Hard-PVC block



NR. no.	VE PU	Breite width	Länge length	Höhe height	
10502	1 St.	250 mm	250 mm	25 mm	

Öseneinschlaghammer
Hammer for eyelet insertion



NR. no.	VE PU	Gewicht weight	Ausführung description
10501	1 St.	1200 g	rückschlagfrei · non-rebounding
10600	1 St.	1780 g	rückschlagfrei · non-rebounding

Ersatzkopf
Replacement head



NR. no.	VE PU	Material material	Ausführung description
11309	1 St.	Kunststoff · plastic	für 1200g-Hammer for 1200g-hammer
11310	1 St.	Kunststoff · plastic	für 1780g-Hammer for 1780g-hammer

Werkzeug zum Montieren von Zollendverschlüssen
Tool for mounting of customs-approved (T.I.R.) end fasteners



NR. no.	VE PU	Ø	Ausführung description
10035	1 St.	6 mm	komplett 4-teilig · completely 4-part
10179	1 St.	8 mm	komplett 4-teilig · completely 4-part



Einzelteile (vom Werkzeugsatz zum Montieren von Zollendverschlüssen)

Individual parts (from the tool set for mounting customs-approved (T.I.R.) end fasteners)



NR. no.	VE PU	Ø	Ausführung description
11465	1 St.	6 mm	Halter für Spitze · tip holder
11466	1 St.	8 mm	Halter für Spitze · tip holder
11467	1 St.	6 + 8 mm	Spitze (gehärtet) · tip (case-hardened)
11464	1 St.	6 mm	Umbördelstempel · punch
11463	1 St.	8 mm	Umbördelstempel · punch
11461	1 St.	6 mm	Unterteil · lower part
11462	1 St.	8 mm	Unterteil · lower part

Breitbandandrückrolle

Wide band pressure roller



NR. no.	VE PU	Breite width	Ausführung description
10233	1 St.	45 mm	einarmig. mit Kugellager single-arm design. with ball bearing
10411	1 St.	45 mm	zweiarmig. mit Kugellager double-arm design. with ball bearing
11023	1 St.	80 mm	zweiarmig. mit Kugellager double-arm design. with ball bearing
11007	1 St.	45 mm	einarmig. ohne Kugellager single-arm design. without ball bearing
11008	1 St.	45 mm	zweiarmig. ohne Kugellager double-arm design. without ball bearing
11024	1 St.	80 mm	zweiarmig. ohne Kugellager double-arm design. without ball bearing
11069	1 St.	9 mm	für Zollnahtschweißband for customs-approved seam welding tape
12409	1 St.	45 mm	Ersatz-Silikonring für Andrückrolle Replacement silicone ring for pressure roller

Arbeitshandschuh (Paar)
Work glove (pair)



NR. no.	VE PU	Ausführung, Material description, material
11189	1 St.	Typ 418 „TOP“ mit Rindnarbenlederbesatz type 418 „TOP“ with cow full-grain leather edging

Nylon-Feinstrick-Handschuh mit Latex-Beschichtung
Nylon-fineknit-glove with latex-coating



NR. no.	VE PU	Ausführung description
12094	1 St.	Größe 7 · size 7
12093	1 St.	Größe 8 · size 8
12092	1 St.	Größe 9 · size 9
12090	1 St.	Größe 10 · size 10
12091	1 St.	Größe 11 · size 11

Ösenmaschine „HT-10-Hydraulik“
Eyeletting machine “HT-10-Hydraulik“

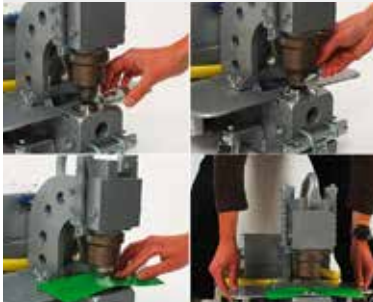

NR. no.	VE PU	Gewicht weight	Ausführung description	Videoanleitung instruction video
11296	1 St.	45 kg (Bügelgewicht 9 kg)	HT-10-HYDRAULIK, elektrohydraulische Öseneinsetz- und Nietmaschine mit 5t Stanzdruck, 230V/50HZ, Ausladung 80 mm electro-hydraulic eyeletting and riveting-machine with 5-t punching compression, 230V/50HZ, radius 80 mm	
11695	1 St.	65 kg (Bügelgewicht 28 kg)	HT-10-HYDRAULIK, elektrohydraulische Öseneinsetz- und Nietmaschine mit 5t Stanzdruck, 230V/50HZ, Ausladung 200 mm · electro-hydraulic eyeletting and riveting-machine with 5-t punching compression, 230V/50HZ, radius 200 mm	
11696	1 St.	83 kg (Bügelgewicht 28 kg)	Tisch-HT-10-HYDRAULIK, elektrohydraulische Öseneinsetz- und Nietmaschine mit 5t Stanzdruck, 230V/50HZ, Ausladung 200 mm, fertig montiert auf fahrbarem Tisch (H = 140 cm, B = 65 cm, L = 120 cm) · electro-hydraulic eyeletting and riveting-machine with 5-t punching compression, 230V/50HZ, ready mounted on a mobile table (H= 140 cm, W = 65 cm, L = 120 cm), radius 200 mm	



Maschinenwerkzeug 2-teilig
Machine tool 2-piece

	NR. no.	VE PU	Ausführung description
 <p>11267</p>	11265	1 St.	für Ø 10 mm Rundösen · for Ø 10 mm round eyelets
	11266	1 St.	für Ø 12 mm Rundösen · for Ø 12 mm round eyelets
	11267	1 St.	für Ø 14 mm Rundösen · for Ø 14 mm round eyelets
	11268	1 St.	für Ø 16 mm Rundösen · for Ø 16 mm round eyelets
	11269	1 St.	für Ø 18 mm Rundösen · for Ø 18 mm round eyelets
	11270	1 St.	für Ø 20 mm Rundösen · for Ø 20 mm round eyelets
	11271	1 St.	für Ø 25 mm Rundösen · for Ø 25 mm round eyelets
 <p>11702</p>	11272	1 St.	für Ø 36 mm Rundösen · for Ø 36 mm round eyelets
	11273	1 St.	für Ø 40 mm Rundösen · for Ø 40 mm round eyelets
	11274	1 St.	für 22.5 x 13.5 mm Ovalösen · for 22.5 x 13.5 mm oval eyelets
	12325	1 St.	für 27 x 7 mm Ovalösen · for 27 x 7 mm oval eyelets
 <p>11701</p>	11275	1 St.	für 42 x 22 mm Ovalösen · for 42 x 22 mm oval eyelets
	12029	1 St.	für Ø 12 mm Zackenösen · for Ø 12 mm toothed eyelets
	12030	1 St.	für Ø 16 mm Zackenösen · for Ø 16 mm toothed eyelets
 <p>11700</p>	12031	1 St.	für Ø 18 mm Zackenösen · for Ø 18 mm toothed eyelets
	12032	1 St.	für Ø 40 mm Zackenösen · for Ø 40 mm toothed eyelets
 <p>11704</p>	11702	1 St.	zum Vernieten von Riemenkrampen mit 51 mm Lochabstand mit selbstlochenden Nietunterlagen · for riveting of strap staples with 51 mm hole spacing and with self-piercing rivet back plates
	11703	1 St.	zum Vernieten von Riemenkrampen mit 34 mm Lochabstand mit selbstlochenden Nietunterlagen · for riveting of strap staples with 34 mm hole spacing and with self-piercing rivet back plates
	11701	1 St.	zum Vernieten von Keder-, Zeltring- und Einhängenhaken mit selbstlochenden Nietunterlagen · for riveting of keder-, tentring- and suspension hooks with self-piercing rivet back plates
	11700	1 St.	zum Vernieten von 2-Loch-Planenhaken aus Kunststoff, Vorhangrollen, Vorhanggleitern mit selbstlochenden Nietunterlagen · for riveting of 2-hole-tarpaulin hooks from plastic, curtain rollers, curtain slider with self-piercing rivet back plate
	11704	1 St.	zum Vernieten von Drehverschlüssen mit 34 mm-Lochabstand mit selbstlochenden Nietunterlagen · for riveting of turnable staples with 34 mm hole spacing and with self-piercing rivet back plates

Handhebelpresse
Hand lever press



NR. no.	VE PU	Ausführung description
11646	1 St.	zum Einsetzen von selbstschneidenden Ø 9 + 12.5 mm Ösen in einem Arbeitsgang (ohne Werkzeug, 11647/11649) · for inserting of self-piercing Ø 9 + 12.5 mm eyelets in one operation (without tool, 11647/11649)
11984	1 St.	zum Einsetzen von Ø 12 mm PVC Ösen (inkl. Werkzeug) for inserting of Ø 12 mm PVC eyelets (incl. tool)

Werkzeug für Handhebelpresse (2-teilig)
Tool for hand lever press (2-piece)



NR. no.	VE PU	Ausführung description
11647	1 St.	für Ø 9 mm selbstschneidende Rundösen (für Handhebelpresse 11646) · for Ø 9 mm self-piercing round eyelets (for hand lever press 11646)
11649	1 St.	für Ø 12.5 mm selbstschneidende Rundösen (für Handhebelpresse 11646) · for Ø 12.5 mm self-piercing round eyelets (for hand lever press 11646)
11985	1 St.	für Ø 12 mm PVC Ösen (für Handhebelpresse 11984) for Ø 12 mm PVC eyelets (for hand lever press 11984)

Ösenhandpresszange
Eyelet hand pressing plier



NR. no.	VE PU	Ausführung description
11626	1 St.	zum Einsetzen von Ø 11 mm selbstschneidende Ösen for insertion of Ø 11 mm self-piercing eyelets



Gesipa Power-Bird Pro Gold Edition Gesipa Power-Bird Pro Gold Edition

	NR. no.	VE PU	Ausführung description
	10814	1 St.	für Blindnieten Ø 4.8 - 7.7 mm, (13 kN Setzkraft), komplett mit Akku und Ladegerät im Koffer · for blind rivets Ø 4.8 - 7.7 mm, (13 kN setting force) supplied in a case, complete with storage battery (accu) and charge
	12377	1 St.	Ersatzakku für Gesipa POWER-BIRD PRO GOLD, 18 V, Li-Ion, 2.0 Amp/h · replacement storage battery for Gesipa POWER-BIRD PRO GOLD, 18 V, Li-Ion, 2.0 Amp/h
	11780	1 St.	Ersatzakku für Gesipa POWER-BIRD, 14.4 V, Li-Ion, 4.0 Amp/h replacement storage battery for Gesipa POWER-BIRD, 14.4 V, Li-Ion, 4.0 Amp/h
	12375	1 St.	Ersatzspannbacken für POWERBIRD PRO Gold, 3 tlg replacement chuck jaws for POWERBIRD PRO Gold. 3 parts
	10818	1 St.	Ersatzspannbacken für Gesipa POWER-BIRD, 3 tlg replacement chuck jaws for Gesipa POWER-BIRD, 3 parts
	12378	1 St.	Ersatzladegerät für POWER-BIRD PRO GOLD replacement charger for Gesipa POWER-BIRD PRO GOLD
	11779	1 St.	Ersatzladegerät für Akku- und Power-Bird replacement charger for accu- and Power-Bird

Bindniethandzange Hand Crimping plier for blind rivets

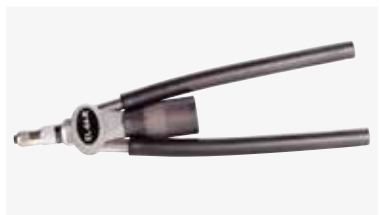
	NR. no.	VE PU	Ausführung description
	10777	1 St.	Werkzeug zum leichten Einsetzen von Blindnieten Ø 3 - 5 mm tool for easy insertion of blind rivets Ø 3 - 5 mm

Bolzenschneider Bolt cutter

	NR. no.	VE PU	Ausführung description
	11553	1 St.	Zum leichten Öffnen von vernieteten Bolzen aus Alu oder Stahl for easy cutting of rivet bolts made of aluminium or steel

KROKOFIX®-Montage KROKOFIX®-Assembly

	NR. no.	VE PU	Ausführung description
	11211	1 St.	Werkzeugplatte zum leichten Montieren von Krokofix® toolplate for easy mounting of Krokofix®

Nietendöpper
Rivet header



NR. no.	VE PU	Ausführung description
11293	1 St.	zum Verarbeiten von selbstlochenden Nieten und Krokofix® for processing of self-piercing rivets and Krokofix®
10932	1 St.	zum Verarbeiten von Hohnieten · for processing of tubular rivets

Einsetzwerkzeug 2-teilig
Insertion tool 2-piece design



NR. no.	VE PU	Ausführung description
10978	1 St.	zum Einsetzen von Druckknöpfen · for insertion of press studs

Handzange und Schere
Crimping plier and cutter



NR. no.	VE PU	Ausführung description
10540	1 St.	Handzange zum leichten Anpressen der NIROSTA-Seilklemmen hand crimping plier for easy pressing of INOX cable clamps
50053	1 St.	Handpresszange zum Verarbeiten von Seilklemmen für Edelstahlseile Ø 1.5 mm · hand crimping plier for easy pressing cable clamps for INOX cables Ø 1.5 mm
50079	1 St.	Drahtseilschere zum Ablängen von Edelstahlseilen · wire rope cutter for easy shortening of INOX cables
11606	1 St.	Zange zum leichten Anpressen von Seilendverschlüssen und Würge- klemmen · tong for easy pressing of cable end clamp and crimping clamps



Heisschneider Hot cutter



NR. no.	VE PU	Ausführung description
11078	1 St.	Typ HSG-0 inkl. Schneidspitze, 60 Watt, Schneidtemperatur ca. 600 °C · Type HSG-0 incl. cutting tip, 60 Watt, cutting temperature approx. 600 °C
11277	1 St.	Schneidspitze für Heißschneider · cutting tip for hot cutter

Zum Schneiden von Gurtbändern und Seilen.
For cutting of webbings and cables.

Handschweissgerät Forsthoﬀ „Made in Germany“ Hand welding tool Forsthoﬀ “Made in Germany”

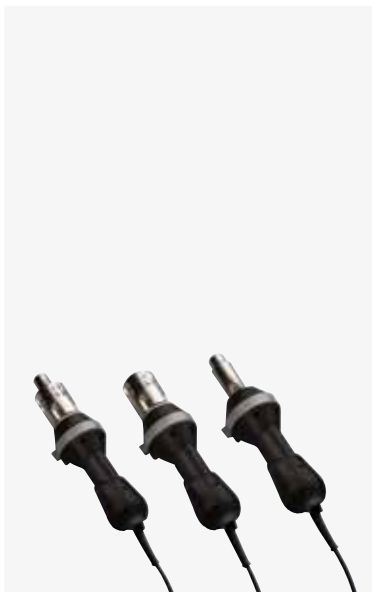

NR. no.	VE PU	Watt watt	Ausführung description
11009	1 St.	900 W	Quick Robust L. inkl. 20 mm-Düse (1 Heiz- und 1 Kaltstufe) Quick Robust L. incl. 20 mm nozzle (1 heat- and 1 cold stepping)
11010	1 St.	1500 W	Quick Robust L. inkl. 40 mm-Düse (1 Heiz- und 1 Kaltstufe) Quick Robust L. incl. 40 mm nozzle (1 heat- and 1 cold stepping)
11011	1 St.	900 W	Quick L. inkl. 20 mm-Düse (2 Heiz- und 1 Kaltstufe) Quick L. incl. 20 mm nozzle (2 heat- and 1 cold stepping)
11012	1 St.	1500 W	Quick L. inkl. 40 mm-Düse (2 Heiz- und 1 Kaltstufe) Quick L. incl. 40 mm nozzle (2 heat- and 1 cold stepping)
11013	1 St.	1500 W	Quick S. inkl. 20 mm Düse. stufenlos 20 - 650°C Quick-S-Electronic. incl. 20 mm nozzle. continuous temperature control in the range 20 - 650°C
11014	1 St.	1500 W	Quick S. inkl. 40 mm Düse. stufenlos 20 - 650°C Quick-S-Electronic. incl. 40 mm nozzle. continuous temperature control in the range 20 - 650°C
11025	1 St.	3000 W	Hot Air S, ohne Düse (nur mit 40 mm Düse verwendbar), stufenlos regelbar 20 - 650 °C, EXTREM STARK Hot Air S, without nozzle (can only be used with 40 mm nozzle), continuous temperature control in the range of 20 - 650 °C. EXTREMELY POWERFUL

Ersatzdüse für Handschweissgeräte Replacement nozzle for handheld welding devices



NR. no.	VE PU	Breite width	Ausführung description
10230	1 St.	20 mm	
10231	1 St.	40 mm	
11017	1 St.	5 mm	rund · round

Überlapp-Schweissautomat Forsthoﬀ-P Overlap welding machine Forsthoﬀ-P



NR. no.	VE PU	Watt watt	Ausführung description
12398	1 St.	3400 W	inkl. 20 mm Düse · incl. 20 mm nozzle
12399	1 St.	4000 W	inkl. 45 mm Düse · incl. 45 mm nozzle

Empfohlen für die Planen-Konfektion.
Recommended for tarpaulin manufacture.

Überlapp-Schweissautomat Forsthoff-P2
Overlap welding machine Forsthoff-P2



NR. no.	VE PU	Watt watt	Ausführung description
11027	1 St.	3400 W	inkl. 20 mm Düse · incl. 20 mm nozzle
11028	1 St.	4000 W	inkl. 45 mm Düse · incl. 45 mm nozzle

Empfohlen für die Banner-Konfektion.
Recommended for banner production.

Gurtband-Schweissautomat Forsthoff-DB
Webbing-welding machine Forsthoff-DB



NR. no.	VE PU	Watt watt	Ausführung description
11029	1 St.	4000 W	inkl. Zubehör zum Schweißen von 50 mm PVC-beschichteten Gurtbändern · incl. accessories for welding 50 mm PVC-coated webbings

Ersatzdüse für Schweißautomaten
Replacement nozzle for welding machine



NR. no.	VE PU	Breite width	Ausführung description
11034	1 St.	20 mm	
11834	1 St.	30 mm	
11835	1 St.	40 mm	
11035	1 St.	45 mm	

Ersatzheizelement
Replacement heating element



NR. no.	VE PU	Watt watt	Ausführung description
11015	1 St.	900 W	für Handschweißgeräte · for hand welding tool
11016	1 St.	1500 W	für Handschweißgeräte · for hand welding tool
12402	1 St.	3000 W	für Handschweißgerät Hot Air S for hand welding tool Hot Air S
11020	1 St.		Ersatzkohlen für Handschweißgeräte (1 Paar, Baujahr 2014 oder älter) · Replacement carbon brushes for hand welders (1 pair, year of construction 2014 or older)
12410	1 St.		Ersatzkohlen für Handschweißgeräte (1 Paar, Baujahr ab 2015) · Replacement carbon brushes for hand welders (1 pair, year of construction from 2015)
11961	1 St.	3400 W	für Schweißautomaten mit 20/30 mm Düse for welding machines with 20/30 mm nozzle
11038	1 St.	4000 W	für Schweißautomaten bis BJ 06/2011 (2 x 2000 W) for automatic welder up to BJ 06/2011 (2 x 2000 W)
11039	1 St.	4000 W	für Schweißautomaten mit 40/45/50 mm Düse for welding machines with 40/45/50 mm nozzle





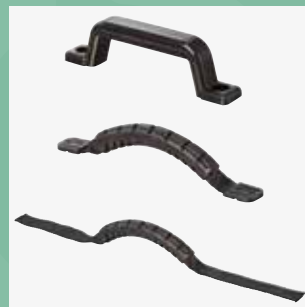

ZUBEHÖR ACCESSORIES



PVC Kleber Plastigum 77

PVC Glue Plastigum 77



NR. no.	VE PU	Ausführung description
10390	1 / 12 St.	0.210 kg-Gebinde (Pinselkleber) 0.210 kg-container (brush glue)
11551	1 / 12 St.	0.638 kg-Gebinde (Dose) 0.638 kg-container (can)

Nicht für Privatgebrauch zugelassen, ideal zum Verkleben von PVC- Planenstoffen.
Not approved for home use, ideal for bonding PVC tarpaulins.

PVC Kleber Saba

PVC Glue Saba



NR. no.	VE PU	Ausführung description
10225	1 / 12 St.	250 ml - Gebinde (Pinselkleber) 250 ml - container (brush glue)

Auch für Privatgebrauch zugelassen.
Also approved for private home use.

Kleber

Adhesive



NR. no.	VE PU	Ausführung description
11983	1 St.	Sprühkleber · adhesive spray

Jowat Karosserie- und Kunstlederkleber

Jowat bodywork- and artificial leather glue



NR. no.	VE PU	Gewicht weight	
10840	1 St.	0.6 kg	

Spray

Spray



NR. no.	VE PU	Ausführung description
11195	1 St.	400 ml, Zinkspray · 400 ml, zinc spray
11199	1 St.	400 ml (Seilspray), Kettenspray 400 ml (Cable spray), chain spray
11200	1 St.	400 ml, Silikonspray (für Dichtungen, PVC- und Gummipflege) 400 ml, silicone spray (for seals, PVC- and rubber care)
11201	1 St.	400 ml, Spray W 44 T (Werkzeugpflege) 400 ml, spray W 44 T (tool care)

Reiniger
Cleaners



NR. no.	VE PU	Ausführung description
11196	1 St.	400 ml, Rostlöser (Kontaktspray) · 400 ml, rust dissolver (contact spray)
11198	1 St.	500 ml, Bremsenreiniger · 500 ml, brake cleaner

Zelttuchimprägniermilch
Impregnation milk for canvas



NR. no.	VE PU	Ausführung description
10226	1 St.	500 ml (für 5 - 7 qm) · 500 ml (for 5 - 7 sqm)

PVC Reiniger (Sprayflasche)
PVC cleaner (spray bottle)



NR. no.	VE PU	Ausführung description
10832	1 St.	500 ml Allesreiniger · 500 ml universal cleaner
11197	1 St.	400 ml PVC- und Universalreinigungsschaum 400 ml PVC and universal cleaning foam

Handschutz PR 88
Hand protecting grip PR 88



NR. no.	VE PU	Ausführung description
11202	1 St.	1000 ml, Handschutz PR 88 (abwaschbar) 1000 ml, hand protector PR 88 (washable)

Schere
Scissor



NR. no.	VE PU	Länge length	Ausführung description
10503	1 St.	240 mm	für Rechtshänder · for right-handers
11506	1 St.	210 mm	für Linkshänder · for left-handers

Zum Schneiden von PVC und anderen Stoffen.
For cutting of PVC and other fabrics.



Zelterdnägel Tent ground nails



NR. no.	VE PU	Länge length	Material · material	Ausführung description
12380	1 St.	50 cm	Stahl verzinkt steel zinc plated	T-Eisenhering T-iron herring
12381	1 St.	23 cm	Stahl verzinkt steel zinc plated	Spezial-Erdnagel Special ground nail

Klebeband Adhesive tape



NR. no.	VE PU	Breite width	Länge length	Ausführung, Material description, material
11162	1 St.	9 mm	50 m	PET-Hochleistungsklebeband, doppelseitig klebend, mit modifiziertem Acrylatklebstoff zum Verkleben von PVC-Stoffen · PET-high performance adhesive tape, double sided adhesion, with modified acrylic adhesive for bonding PVC-fabrics
11609	1 St.	25 mm	50 m	
11610	1 St.	40 mm	50 m	
11636	1 St.	10 mm	100 m	Schmelzklebeband, zum Verschweißen von PVC-freien Stoffen wie Baumwoll-, Markisen-, Fahnenstoffen und anderen Textilien mit HF, Heizkeil oder Heißluft hot-melt adhesive tape, for welding of PVC-free fabrics such as cotton-, awning-, flag-fabrics and other textiles with HF, heated wedge or hot air
11637	1 St.	20 mm	100 m	
11747	1 St.	25 mm	50 m	Flachkreppeklebeband, einseitig klebend flat-crepe-tape, single-sided adhesion
50324	1 St.	40 mm	25 lfm	Power Tape, weiß, HD PE Folie zum Verstärken und zur Ersparnis von Falzen und Säumen power tape, white, HD PE foil for reinforcement and for avoiding folds and seams
11742	1 St.	25 mm	33 m	Hochleistungsacrylat, doppelseitig klebend, gute Klebkraft auf festen Untergründen wie Metall · high performance acrylate, double-sided adhesion, good adhesion to solid surfaces such as metal
11740	1 St.	50 mm	50 m	Gewebeklebeband, PE-beschichtet, Panzerband fabric tape, PE-coated, ultra-strong duct tape
11741	1 St.	25 mm	50 m	Gittergewebe zur Verklebung von Textilien mesh for bonding textiles
11745	1 St.	25 mm	33 m	Vliesklebeband, doppelseitig klebend, zur Verklebung von RollUps, Papier, Folie non-woven adhesive tape, double-sided adhesion, for bonding RollUps, paper and foil
11749	1 St.	9 mm	66 mm	PET-Folienklebeband, einseitig klebend, Anwendung: gut auf Silikonpapier z.B. zur Folienmontage · PET film adhesive tape, single-sided adhesion, ideal for use on silicone paper e.g. for film mounting

Reparatur-Planenstoff 650 g/m²
 Repair-tarpaulin 650 g/m²



NR. no.	VE PU	Breite width	Länge length	Farbe · colour	Ausführung · description
11616	1 St.	50 mm	5 m	blau · blue	RAL 5010
11617	1 St.	50 mm	5 m	hellgrau · light grey	RAL 7038
11618	1 St.	50 mm	5 m	schwarz · black	RAL 9005
11619	1 St.	50 mm	5 m	weiß · white	RAL 9010
11620	1 St.	50 mm	5 m	silber · silver	RAL 9006
11854	1 St.	100 mm	5 m	orange · orange	RAL 2011
11364	1 St.	50 mm	5 m	rot · red	RAL 3002

- einseitig selbstklebend zum Reparieren von eingerissenen Planen und mehr
- weitere Farben vom 100 mm breiten Reparaturplanenstoff gibt es auf Anfrage

- self-adhesive on one side for repairing ripped tarpaulin and more
- further colours from the 100 mm wide repair tarpaulin is available upon request

Schlagschnur
 Chalk line



NR. no.	VE PU	Länge length	Gewicht weight	Ausführung description
11001	1 St.	30 m		Roller · reel
11002	1 St.		250 g	Pulver. rot · powder. red
11789	1 St.		250 g	Pulver. blau · powder. blue

Handgriff aus Kunststoff
 Hand grip plastic



NR. no.	VE PU	Breite width	Länge length	↔	Farbe colour	Ausführung, Material description, material
10989	1 St.		190 mm		schwarz black	Stahl und Kunststoff beschichtet · steel- and plastic coated
10979	1 St.		260 mm		schwarz black	zum Vernieten, mit PP-Gurt for riveting, with PP-belt
10980	1 St.		480 mm		schwarz black	zum Vernähen, mit PP-Gurt (Griffmaß: 160 mm) · for sewing with PP-belt (grip size: 160 mm)
11979	1 St.	25 mm	285 mm	28 mm	schwarz black	zum Vernieten, aus Riemenmaterial · for riveting, from belt material
12423	1 St.	25 mm	350 mm	28 mm	beige beige	zum Vernieten, aus Riemenmaterial · for riveting, from belt material

Glaserwinkel mit Verstrebung
 Glaser angle with brace



NR. no.	VE PU	Breite width	Länge length
12099	1 St.	60 cm	205 cm
12100	1 St.	70 cm	250 cm



NACHHALTIGKEIT



Stets den Umweltschutz und die Nachhaltigkeit im Blick, sind wir besonders in diesem Bereich unermüdlich auf der Suche nach möglichen Alternativen und Innovationen sowohl im Produkt- als auch im Verpackungsmittelbereich. Wir bleiben kreativ und ideenreich für Sie.

Always focussing on environmental protection and sustainability, we are constantly on the lookout for possible alternatives and innovations in this area in particular, both in terms of products and packaging. We remain creative and full of ideas for you.





st®
STARKE

tecoshgn®
BEST WAY TO PERFORM

Benedikt Starke GmbH & Co. KG
Lockweg 85-87 D-59846 Sundern
Fon +49 (0) 2933 - 92 22 49-0
Fax +49 (0) 2933 - 92 22 49-49
info@bstarke.de
www.bstarke.de

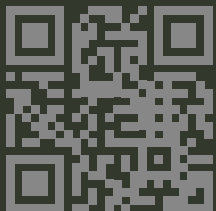

Benedikt Starke GmbH & Co. KG
Lockweg 85-87
59846 Sundern (DE)
Fon: +49 (0) 29 33 - 92 22 49 - 0
E-Mail: info@bstarke.de
www.bstarke.de